



MAHARERA NO.:

PM1261012502409

maharera.maharashtra.gov.in



ECHOES

2 & 2.5 BHK Timeless Homes

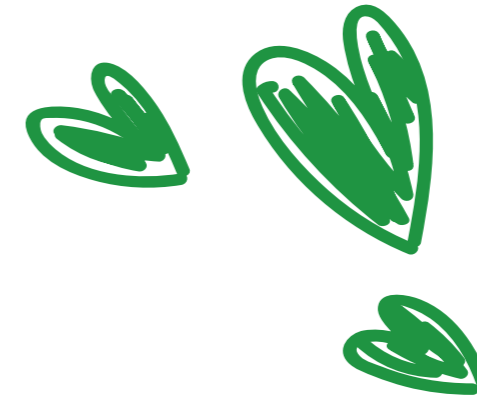

**Simple, happy, innocent, playful
and unforgettable...**

**Don't you miss
your childhood sometimes?**

Well, enough of missing it!





Presenting, a



that

ECHOOES

with your
childhood!



An artistic rendering of a modern high-rise apartment complex. The image shows several tall, multi-story buildings with a light-colored facade and numerous windows. The buildings are set against a dramatic sky with soft, colorful clouds in shades of blue, orange, and pink, suggesting a sunset or sunrise. In the foreground, there are palm trees and other tropical vegetation, along with a road and streetlights. The overall atmosphere is serene and modern.

A haven of old and new memories.

~5.89 Acres Area

Launching Towers A, B & E

40+ Amenities Across 3 Levels

A Part of 400+ Acre Township



Artist's impression

Grand Entrance

Your gateway to a life filled with timeless moments



Artist's impression

Lap Pool

A tranquil flow of happiness.



Artist's impression

Outdoor Kids Play Area

For a childhood that feels free.



Artist's impression

Living Room

Where everyday moments feel special



MASTER PLAN



MASTER PLAN



Legend

- A. Access Road
- B. Residential Entry / Exit
- C. Commercial Entry / Exit
- D. Contemplation Park
- E. Entrance To Terrace
- F. Viewing Deck

Phase - 1 (Tower A, B & E)

Ground Floor Amenities

- 1. Badminton Hall

Podium Landscape Amenities

- 2. Outdoor Lounge
- 3. Lawn
- 4. Toddler's Play Area
- 5. Multipurpose Court
- 6. Cricket Practice Net
- 7. Outdoor Gym
- 8. Senior Citizen Pavilion
- 9. Reflexology Path
- 10. Meditation Pod

Phase - 2 (Tower C & D)

Ground Floor Landscape Amenities

- 11. Walking Track
- 12. Flower Garden
- 13. Aroma Garden
- 14. Herb Garden

Podium Landscape Amenities

- 15. Swimming Pool
- 16. Jacuzzi
- 17. Kids' Pool
- 18. Underwater Seats
- 19. Cabana
- 20. Tiered Seating
- 21. Stage
- 22. Party Lawn
- 23. Service Counter
- 24. Sunken Seating
- 25. Kids' Play Area
- 26. Pavilion Seating
- 27. Swing Plaza

- 28. Community Center
 - a. Gymnasium
 - b. Yoga & Zumba
 - c. Multipurpose Hall

Terrace Amenities

Phase 1 & Phase 2

- 29. Multipurpose Lawn (Artificial)
- 30. Deck With Seating
- 31. Service Counter

FLOOR PLAN TOWER A



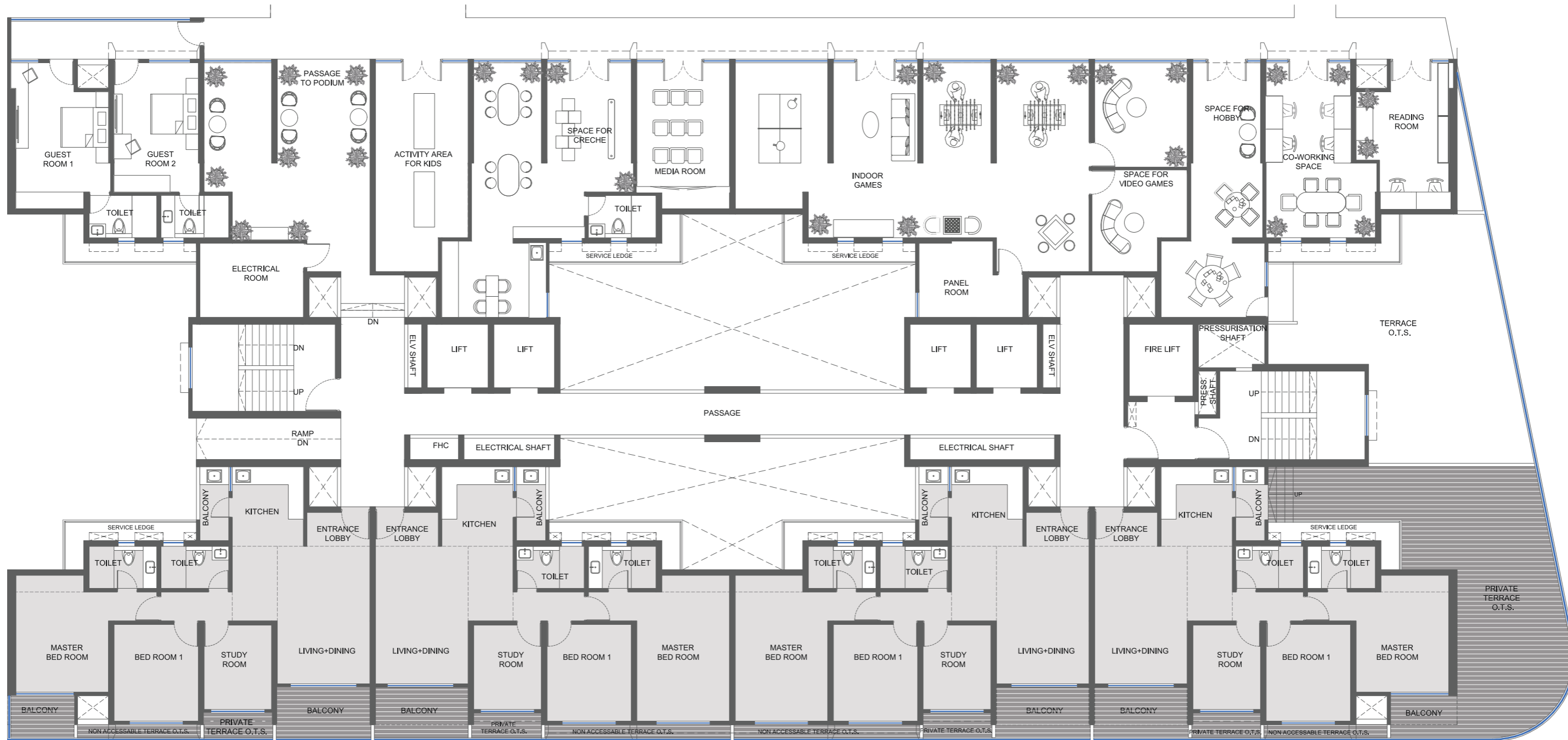

108

107

106

105

TOWER A (1st Floor Plan)

UNIT TYPE	FLAT NUMBERS	FLAT CARPET AREA (SQ. M)	FLAT CARPET AREA (SQ. FT.)	BALCONY AREA (SQ. M.)	BALCONY AREA (SQ. FT.)	PRIVATE TERRACE AREA (SQ. M.)	PRIVATE TERRACE AREA (SQ. FT.)
2.5 BHK MEMORIA	105	80.76	869.30	10.09	108.61	56.28	605.80
2.5 BHK MEMORIA	106	84.23	906.65	7.33	78.90	3.85	41.44
2.5 BHK MEMORIA	107	84.23	906.65	7.33	78.90	3.85	41.44
2.5 BHK MEMORIA	108	80.76	869.30	9.72	104.63	4.93	53.07

- All Dimensions Are In Meter Unless Otherwise Specified
- Dimensions & Areas Additionally Mentioned in Feet Inches & Square Feet Are Only For Customer's Understanding. Kindly Do Not Refer The Same For Any RERA Related Reference.



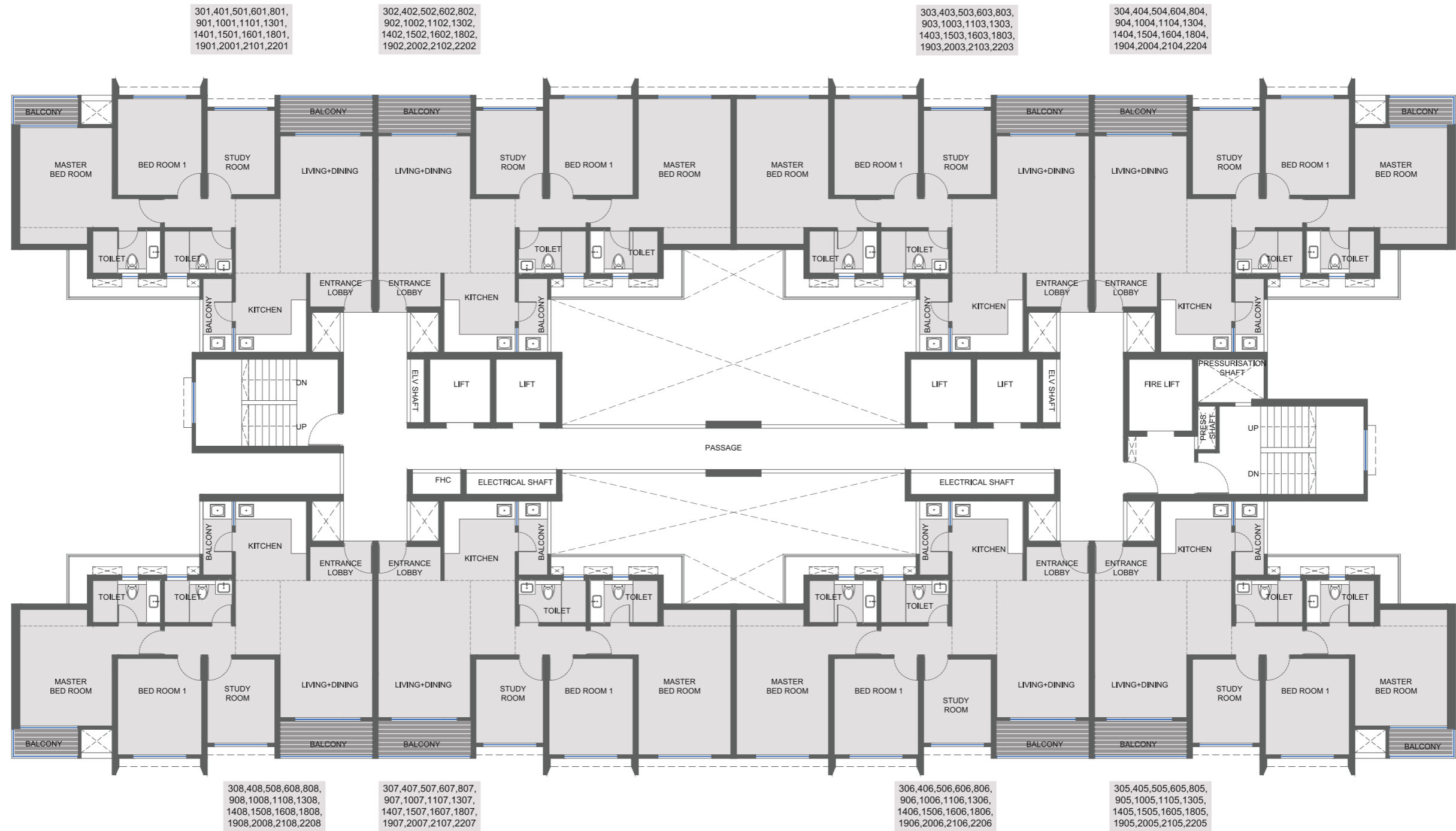

TOWER A
 (3rd, 4th, 5th, 6th, 8th,
 9th, 10th, 11th, 13th,
 14th, 15th, 16th, 18th,
 19th, 20th, 21th & 22th
 Floor Plan)

UNIT TYPE	FLAT NUMBERS	FLAT CARPET AREA (SQ.M.)	FLAT CARPET AREA (SQ.FT.)	BALCONY AREA (SQ.M.)	BALCONY AREA (SQ.FT.)
2.5 BHK MEMORIA	301, 401, 501, 601, 801, 901, 1001, 1101, 1301, 1401, 1501, 1601, 1801, 1901, 2001, 2101, 2201, 304, 404, 504, 604, 804, 904, 1004, 1104, 1304, 1404, 1504, 1604, 1804, 1904, 2004, 2104, 2204, 305, 405, 505, 605, 805, 905, 1005, 1105, 1305, 1405, 1505, 1605, 1805, 1905, 2005, 2105, 2205, 308, 408, 508, 608, 808, 908, 1008, 1108, 1308, 1408, 1508, 1608, 1808, 1908, 2008, 2108, 2208	80.52	866.72	9.02	97.09
2.5 BHK MEMORIA	302, 402, 502, 602, 802, 902, 1002, 1102, 1302, 1402, 1502, 1602, 1802, 1902, 2002, 2102, 2202, 303, 403, 503, 603, 803, 903, 1003, 1103, 1303, 1403, 1503, 1603, 1803, 1903, 2003, 2103, 2203, 306, 406, 506, 606, 806, 906, 1006, 1106, 1306, 1406, 1506, 1606, 1806, 1906, 2006, 2106, 2206, 307, 407, 507, 607, 807, 907, 1007, 1107, 1307, 1407, 1507, 1607, 1807, 1907, 2007, 2107, 2207	83.98	903.96	6.91	74.38

- All Dimensions Are In Meter Unless Otherwise Specified
- Dimensions & Areas Additionally Mentioned in Feet Inches & Square Feet Are Only For Customer's Understanding. Kindly Do Not Refer The Same For Any RERA Related Reference.



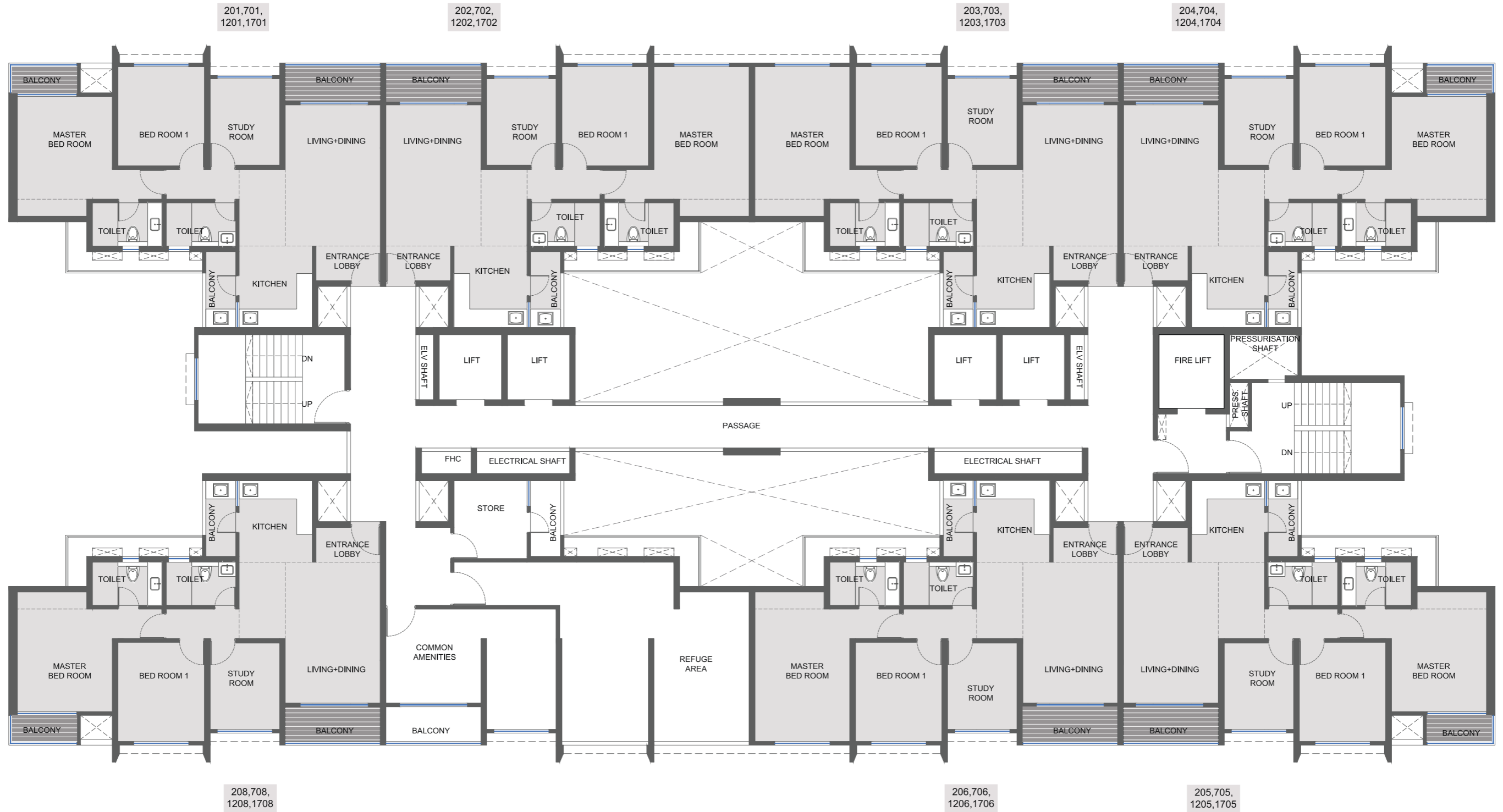

TOWER A
(2nd, 7th, 12th, & 17th
Refuge Floor Plan)

UNIT TYPE	FLAT NUMBERS	FLAT CARPET AREA (SQ.M.)	FLAT CARPET AREA (SQ.FT.)	BALCONY AREA (SQ.M.)	BALCONY AREA (SQ.FT.)
2.5 BHK MEMORIA	201, 701, 1201, 1701, 204, 704, 1204, 1704, 205, 705, 1205, 1705, 208, 708, 1208, 1708	80.52	866.72	9.02	97.09
2.5 BHK MEMORIA	202, 702, 1202, 1702, 203, 703, 1203, 1703, 206, 706, 1206, 1706	83.98	903.96	6.91	74.38

1. All Dimensions Are In Meter Unless Otherwise Specified
2. Dimensions & Areas Additionally Mentioned in Feet Inches & Square Feet Are Only For Customer's Understanding. Kindly Do Not Refer The Same For Any RERA Related Reference.



UNIT PLAN

TOWER A



TOWER A

2.5 BHK MEMORIA + PRIVATE TERRACE

Flat Carpet Area (Sq.m./Sq.ft):	80.76 / 869.30
Balcony Area (Sq.m./Sq.ft):	9.72 / 104.63
Private Terrace Area (Sq.m./Sq.ft):	4.93 / 53.07

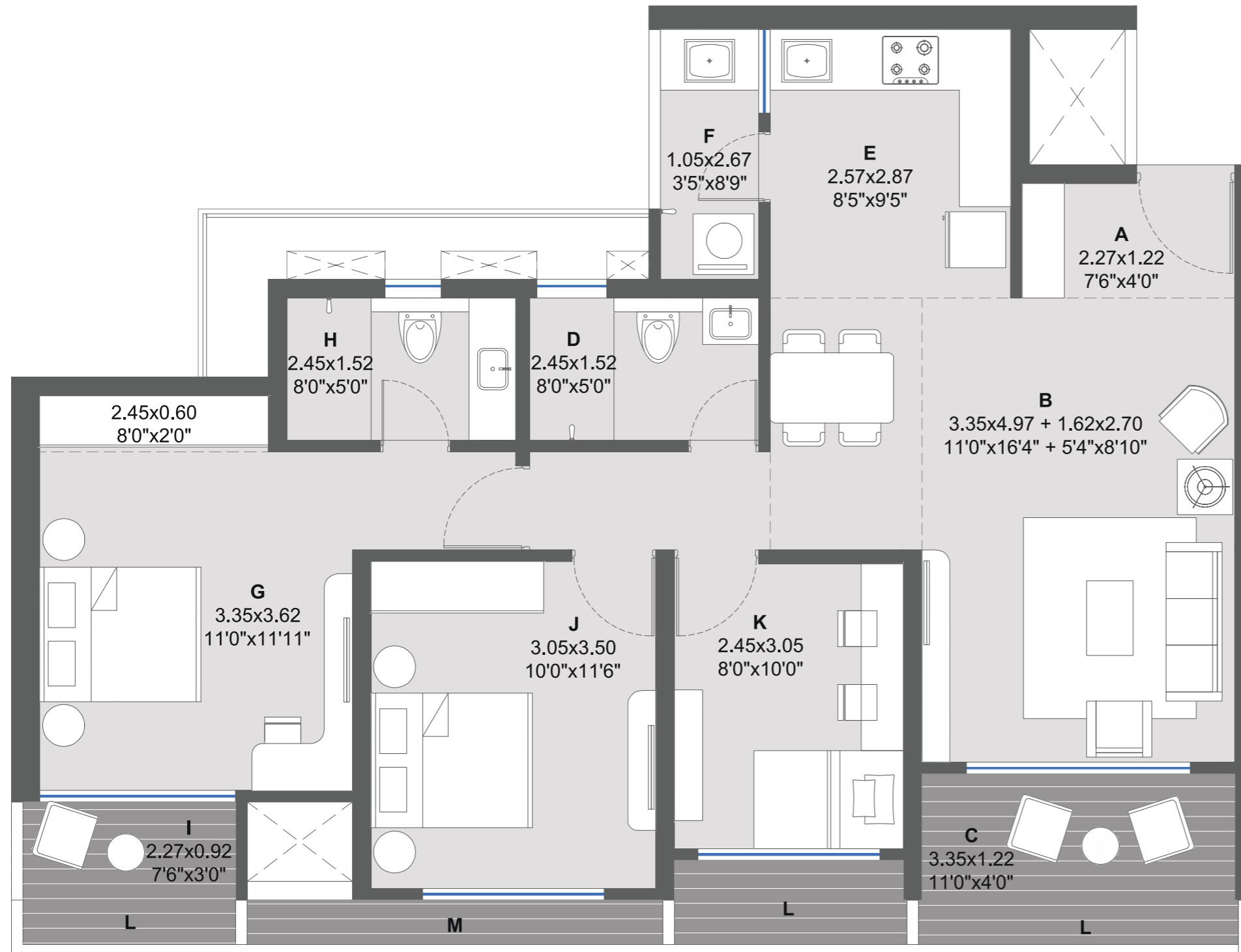

LIVING SPACE

- A. ENTRANCE LOBBY
- B. LIVING + DINING
- C. BALCONY
- D. TOILET

KITCHEN SPACE

- E. KITCHEN
- F. BALCONY

BEDROOMS

- G. MASTER BEDROOM
- H. TOILET
- I. BALCONY
- J. BEDROOM 01
- K. STUDY ROOM
- L. PRIVATE TERRACE
- M. NON ACCESIBLE TERRACE

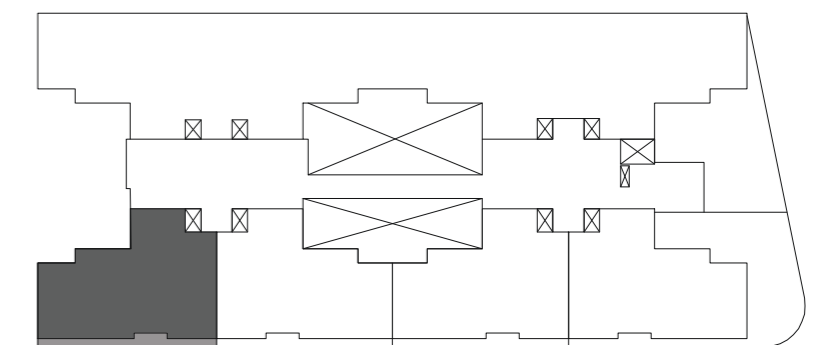

FIRST FLOOR - FLAT NO. 108

1. All Dimensions Are In Meter Unless Otherwise Specified
2. Dimensions & Areas Additionally Mentioned in Feet Inches & Square Feet Are Only For Customer's Understanding. Kindly Do Not Refer The Same For Any RERA Related Reference.



TOWER A

2.5 BHK MEMORIA + PRIVATE TERRACE

Flat Carpet Area (Sq.m./Sq.ft) :	84.23 / 906.65
Balcony Area (Sq.m./Sq.ft) :	7.33 / 78.90
Private Terrace Area (Sq.m./Sq.ft) :	3.85 / 41.44

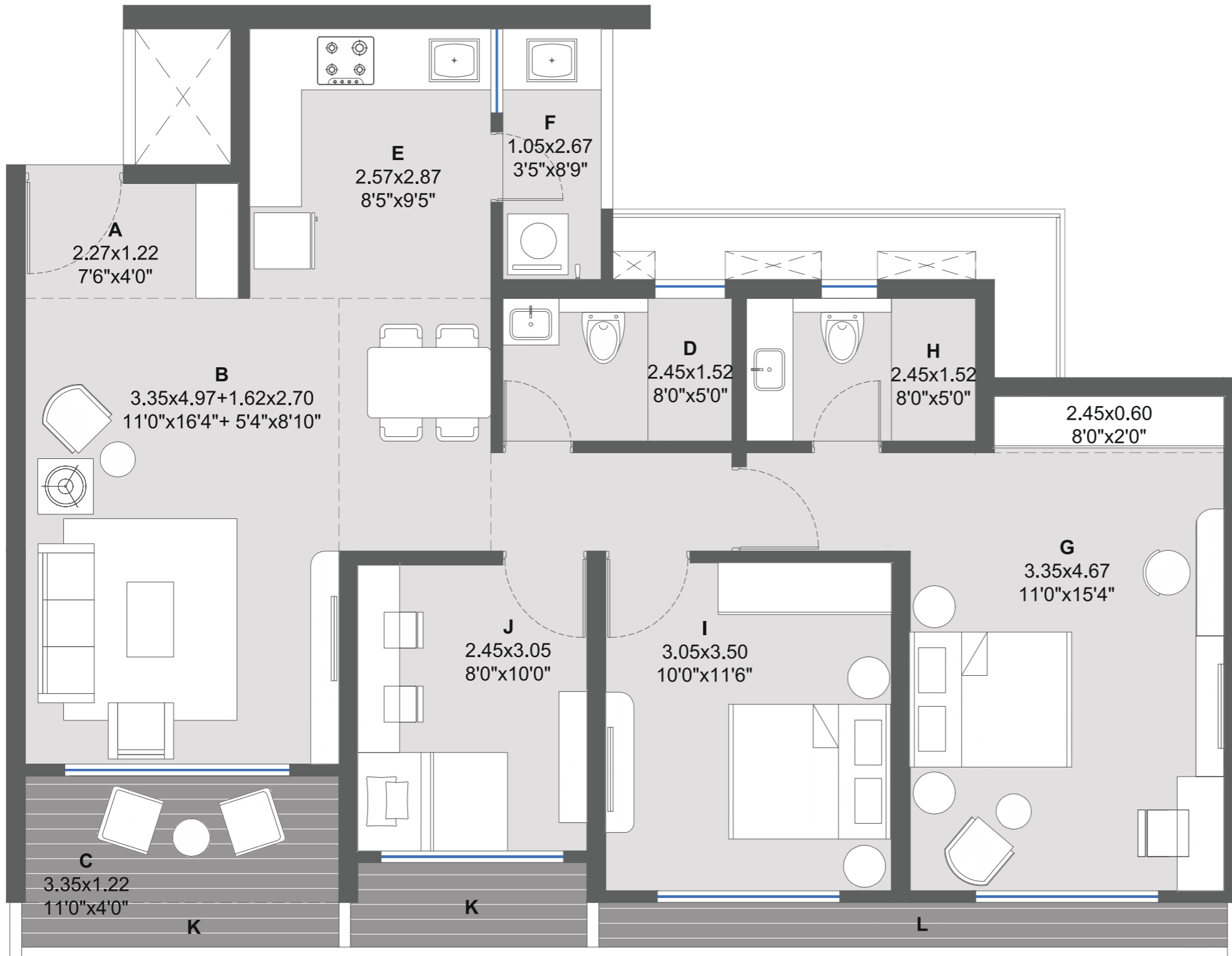

LIVING SPACE

- A. ENTRANCE LOBBY
- B. LIVING + DINING
- C. BALCONY
- D. TOILET

KITCHEN SPACE

- E. KITCHEN
- F. BALCONY

BEDROOMS

- G. MASTER BEDROOM
- H. TOILET
- I. BEDROOM 01
- J. STUDY ROOM
- K. PRIVATE TERRACE
- L. NON ACCESIBLE TERRACE

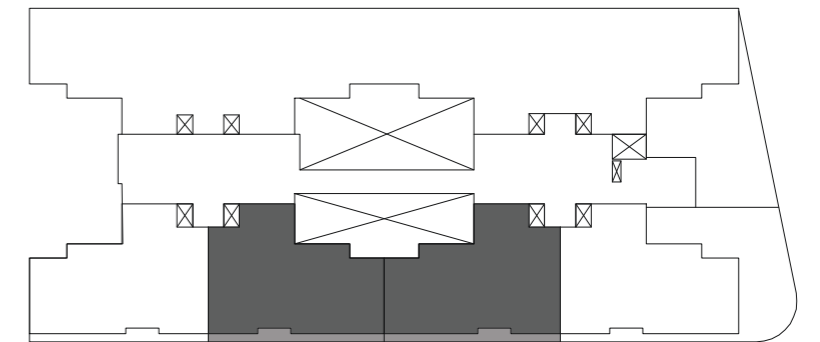

FIRST FLOOR - FLAT NO. 106/107

1. All Dimensions Are In Meter Unless Otherwise Specified
2. Dimensions & Areas Additionally Mentioned in Feet Inches & Square Feet Are Only For Customer's Understanding. Kindly Do Not Refer The Same For Any RERA Related Reference.



TOWER A

2.5 BHK MEMORIA + PRIVATE TERRACE

Flat Carpet Area (Sq.m./Sq.ft) :	80.76 / 869.30
Balcony Area (Sq.m./Sq.ft) :	10.09 / 108.61
Private Terrace Area (Sq.m./Sq.ft) :	56.28 / 605.80

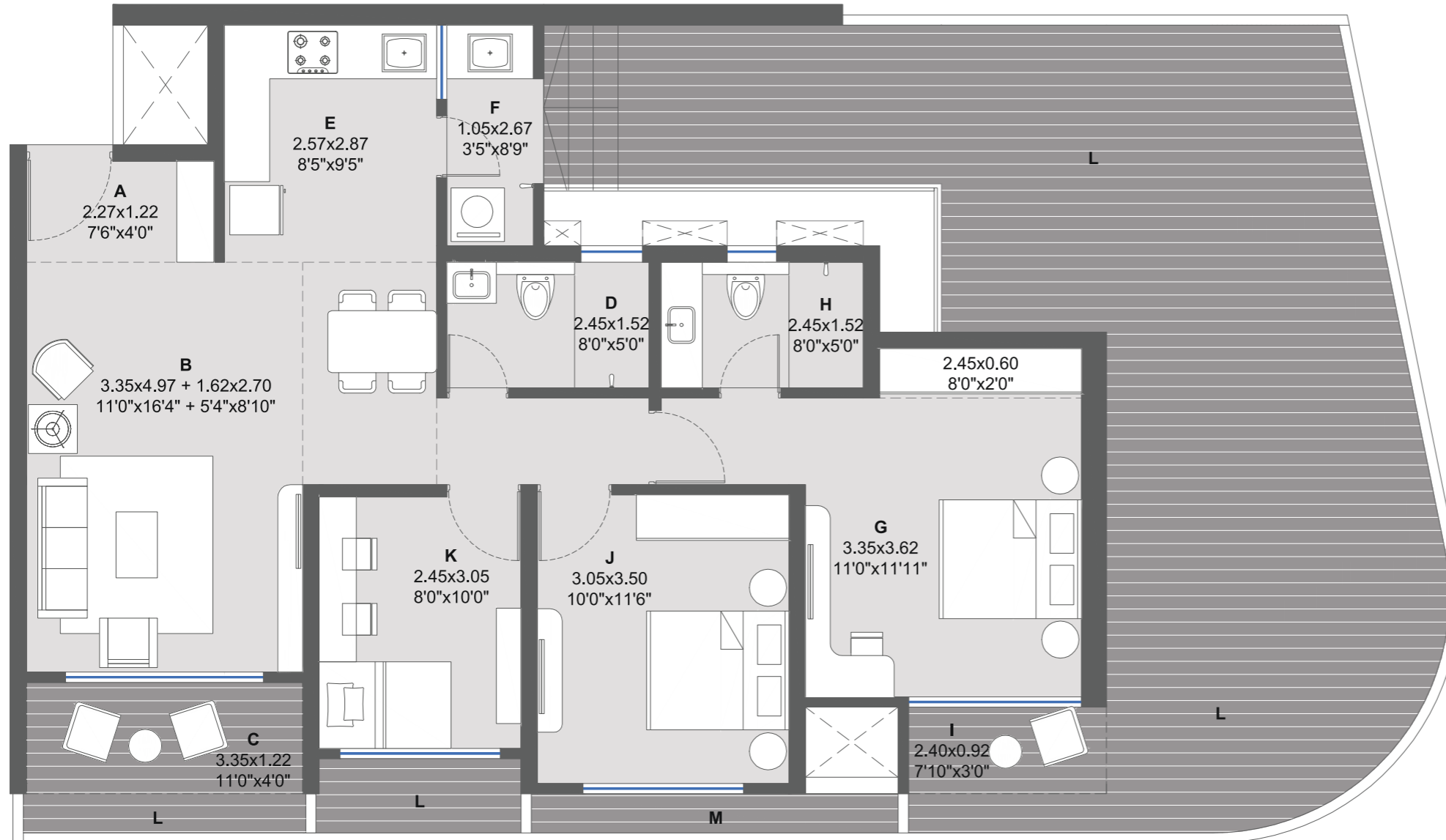

LIVING SPACE

- A. ENTRANCE LOBBY
- B. LIVING + DINING
- C. BALCONY
- D. TOILET

KITCHEN SPACE

- E. KITCHEN
- F. BALCONY

BEDROOMS

- G. MASTER BEDROOM
- H. TOILET
- I. BALCONY
- J. BEDROOM 01
- K. STUDY ROOM
- L. PRIVATE TERRACE
- M. NON ACCESIBLE TERRACE

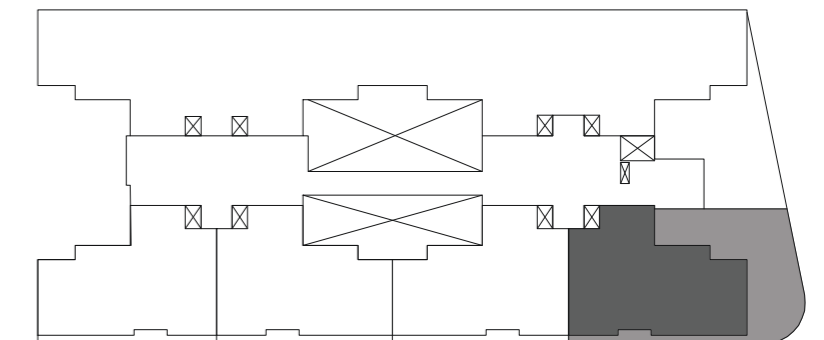

FIRST FLOOR - FLAT NO. 105

1. All Dimensions Are In Meter Unless Otherwise Specified
2. Dimensions & Areas Additionally Mentioned in Feet Inches & Square Feet Are Only For Customer's Understanding. Kindly Do Not Refer The Same For Any RERA Related Reference.



TOWER A

2.5 BHK MEMORIA

Flat Carpet Area (Sq.m./Sq.ft) : 80.52 / 866.72
 Balcony Area (Sq.m./Sq.ft) : 9.02 / 97.09

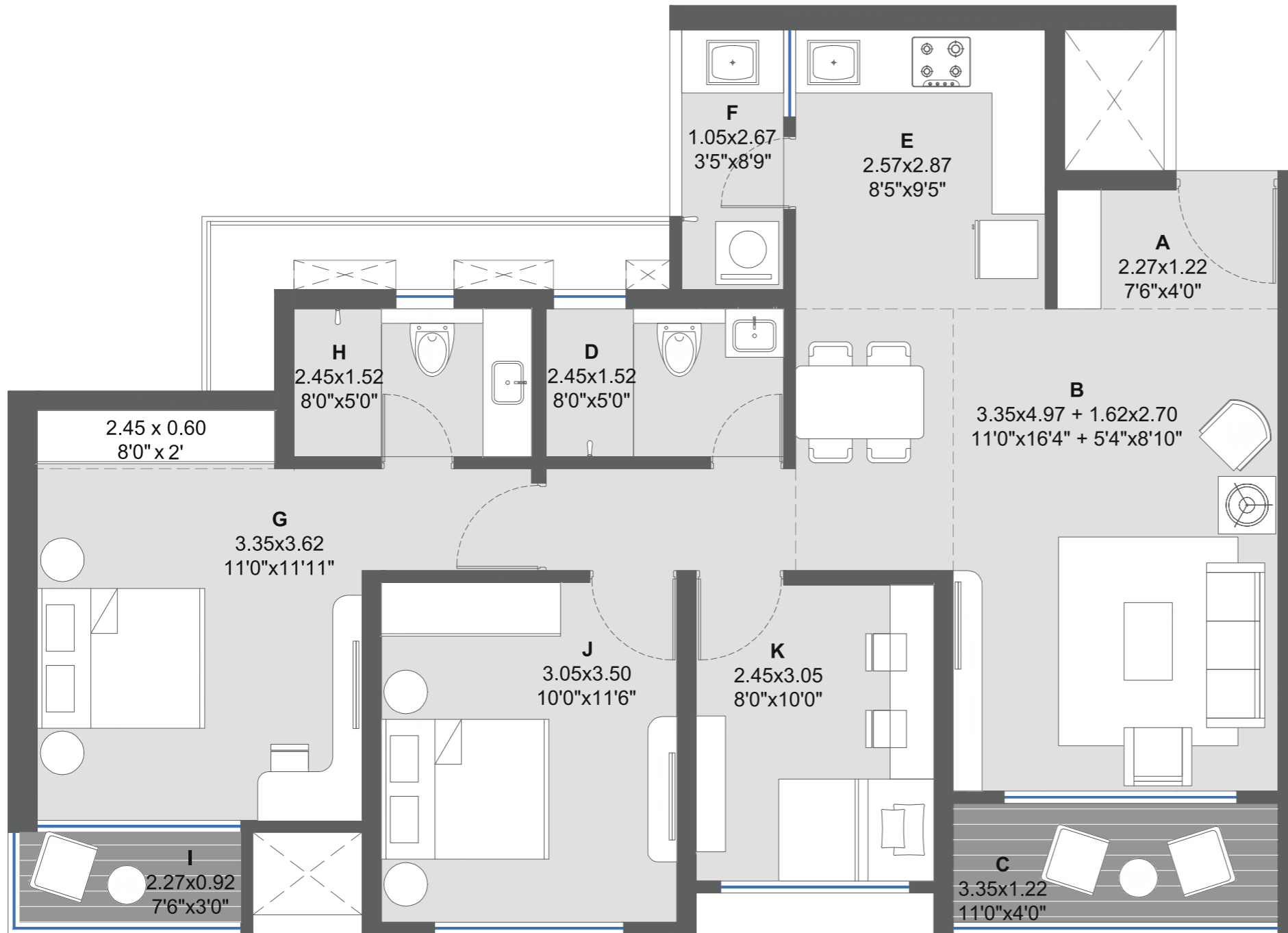

LIVING SPACE

- A. ENTRANCE LOBBY
- B. LIVING + DINING
- C. BALCONY
- D. TOILET

BEDROOMS

- G. MASTER BEDROOM
- H. TOILET
- I. BALCONY
- J. BEDROOM 01
- K. STUDY ROOM

KITCHEN SPACE

- E. KITCHEN
- F. BALCONY

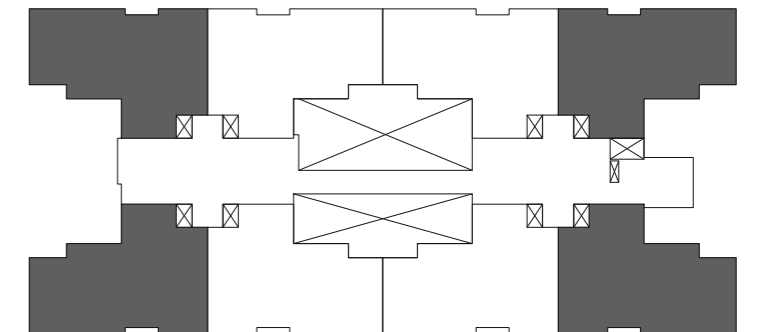

TYPICAL FLOOR - FLAT NO. 01/ 04/ 05/ 08.

1. All Dimensions Are In Meter Unless Otherwise Specified
2. Dimensions & Areas Additionally Mentioned in Feet Inches & Square Feet Are Only For Customer's Understanding. Kindly Do Not Refer The Same For Any RERA Related Reference.



TOWER A

2.5 BHK MEMORIA

Flat Carpet Area (Sq.m./Sq.ft) : 83.98 / 903.96
 Balcony Area (Sq.m./Sq.ft) : 6.91 / 74.38

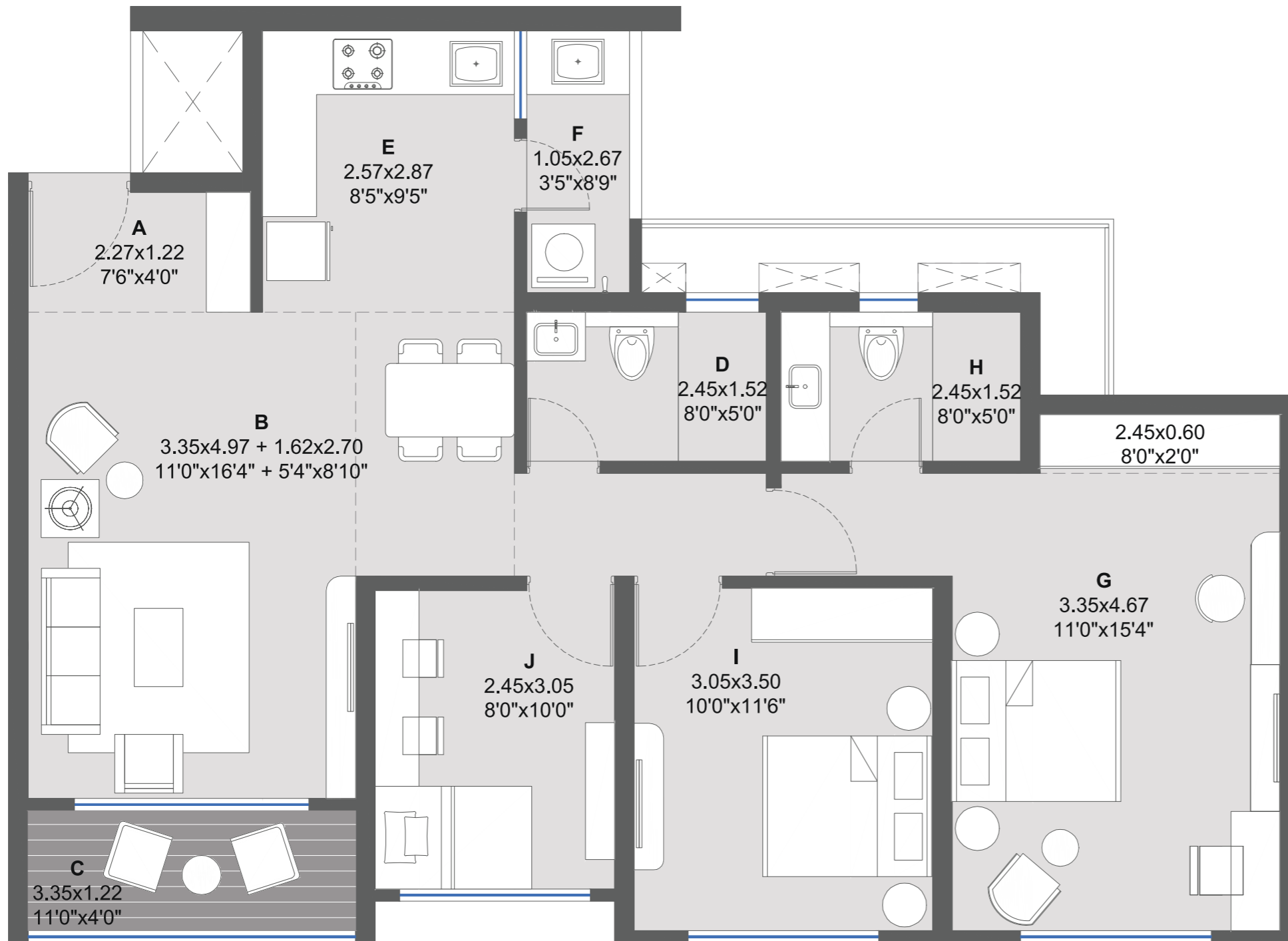

LIVING SPACE

- A. ENTRANCE LOBBY
- B. LIVING + DINING
- C. BALCONY
- D. TOILET

BEDROOMS

- G. MASTER BEDROOM
- H. TOILET
- I. BEDROOM 01
- J. STUDY ROOM

KITCHEN SPACE

- E. KITCHEN
- F. BALCONY

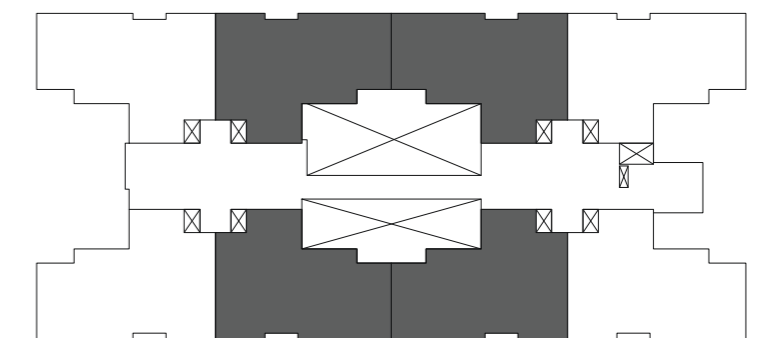

TYPICAL FLOOR - FLAT NO. 02/ 03/ 06/ 07.

1. All Dimensions Are In Meter Unless Otherwise Specified
2. Dimensions & Areas Additionally Mentioned in Feet Inches & Square Feet Are Only For Customer's Understanding. Kindly Do Not Refer The Same For Any RERA Related Reference.





FLOOR PLAN

TOWER B

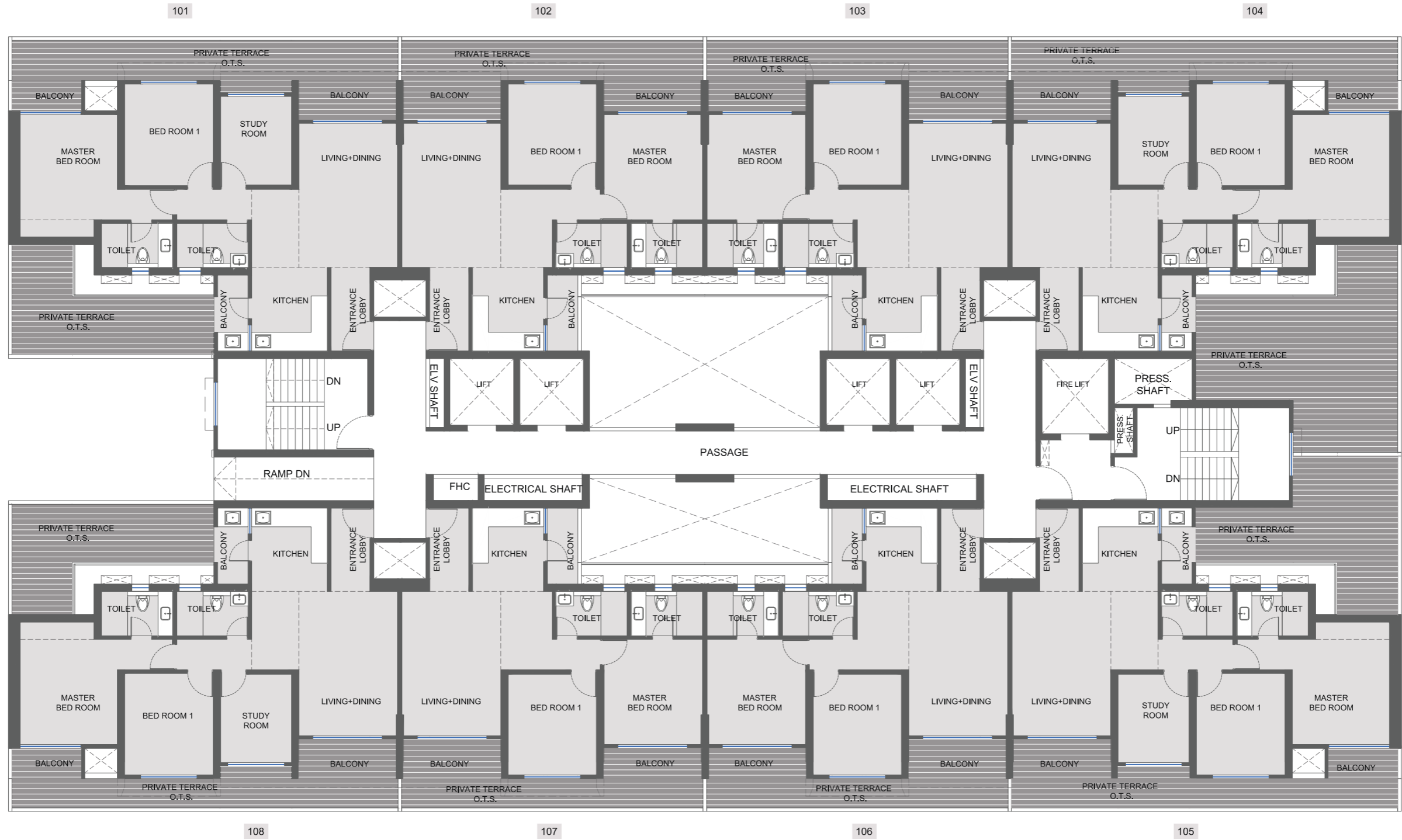

TOWER B (1st Floor Plan)

UNIT TYPE	FLAT NUMBERS	FLAT CARPET AREA (SQ. M)	FLAT CARPET AREA (SQ. FT.)	BALCONY AREA (SQ. M.)	BALCONY AREA (SQ. FT.)	PRIVATE TERRACE AREA (SQ. M.)	PRIVATE TERRACE AREA (SQ. FT.)
2.5 BHK MEMORIA	101	82.77	890.94	10.01	107.75	36.95	397.73
2 BHK MOMENT	102	70.09	754.45	10.80	116.25	14.26	153.49
2 BHK MOMENT	103	70.09	754.45	10.80	116.25	14.26	153.49
2.5 BHK MEMORIA	104	82.77	890.94	10.01	107.75	54.32	584.70
2.5 BHK MEMORIA	105	82.77	890.94	10.01	107.75	37.53	403.97
2 BHK MOMENT	106	70.09	754.45	10.80	116.25	10.37	111.62
2 BHK MOMENT	107	70.09	754.45	10.80	116.25	10.37	111.62
2.5 BHK MEMORIA	108	82.77	890.94	10.01	107.75	31.96	344.02

1. All Dimensions Are In Meter Unless Otherwise Specified
2. Dimensions & Areas Additionally Mentioned in Feet Inches & Square Feet Are Only For Customer's Understanding. Kindly Do Not Refer The Same For Any RERA Related Reference.



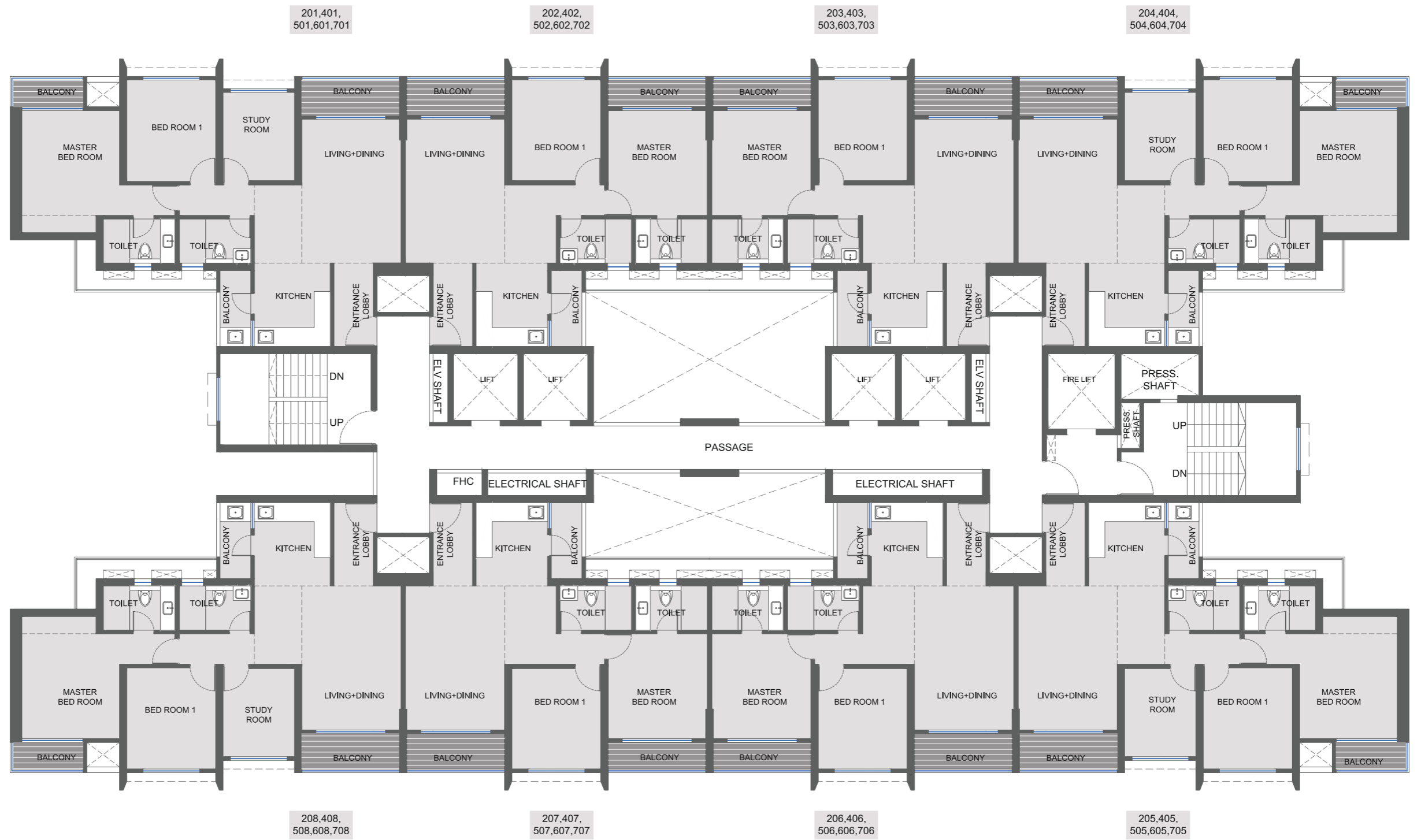

TOWER B
(2nd, 4th, 5th,
6th, & 7th
Floor Plan)

UNIT TYPE	FLAT NUMBERS	FLAT CARPET AREA (SQ.M.)	FLAT CARPET AREA (SQ.FT.)	BALCONY AREA (SQ.M.)	BALCONY AREA (SQ.FT.)
2.5 BHK MEMORIA	201, 401, 501, 601, 701, 204, 404, 504, 604, 704, 205, 405, 505, 605, 705, 208, 408, 508, 608, 708	82.77	890.94	9.05	97.41
2 BHK MOMENT	202, 402, 502, 602, 702, 203, 403, 503, 603, 703, 206, 406, 506, 606, 706, 207, 407, 507, 607, 707	70.09	754.45	9.96	107.21

1. All Dimensions Are In Meter Unless Otherwise Specified
2. Dimensions & Areas Additionally Mentioned in Feet Inches & Square Feet Are Only For Customer's Understanding. Kindly Do Not Refer The Same For Any RERA Related Reference.



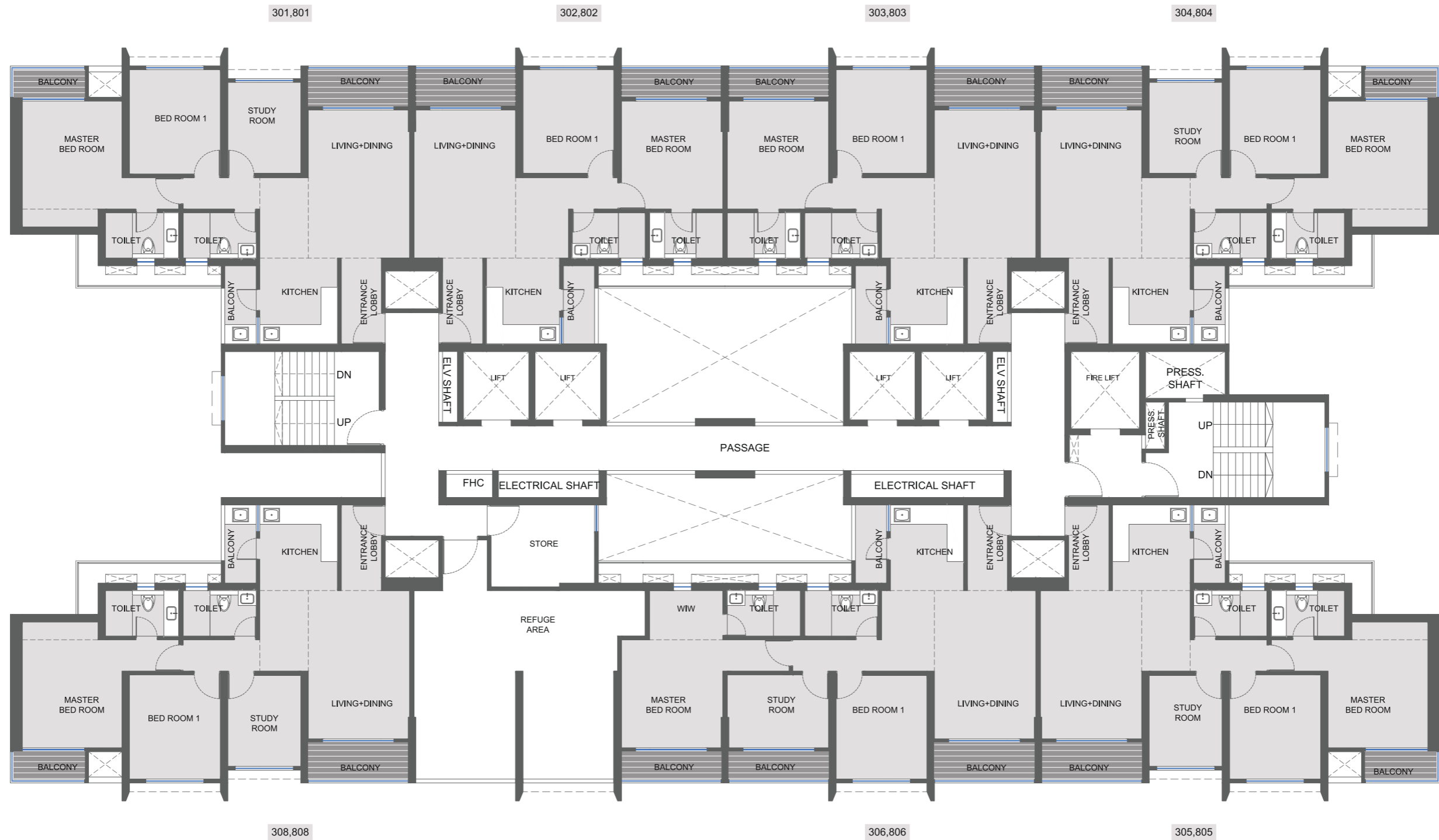

TOWER B
 (3rd & 8th
 Refuge Floor Plan)

UNIT TYPE	FLAT NUMBERS	FLAT CARPET AREA (SQ.M.)	FLAT CARPET AREA (SQ.FT.)	BALCONY AREA (SQ.M.)	BALCONY AREA (SQ.FT.)
2.5 BHK MEMORIA	301, 801, 304, 804, 305, 805, 308, 808.	82.77	890.94	9.05	97.41
2 BHK MOMENT	302, 802, 303, 803.	70.09	754.45	9.96	107.21
2.5 BHK MEMORIA (REFUGE)	306, 806	87.75	944.54	13.06	140.58

1. All Dimensions Are In Meter Unless Otherwise Specified
2. Dimensions & Areas Additionally Mentioned in Feet Inches & Square Feet Are Only For Customer's Understanding. Kindly Do Not Refer The Same For Any RERA Related Reference.



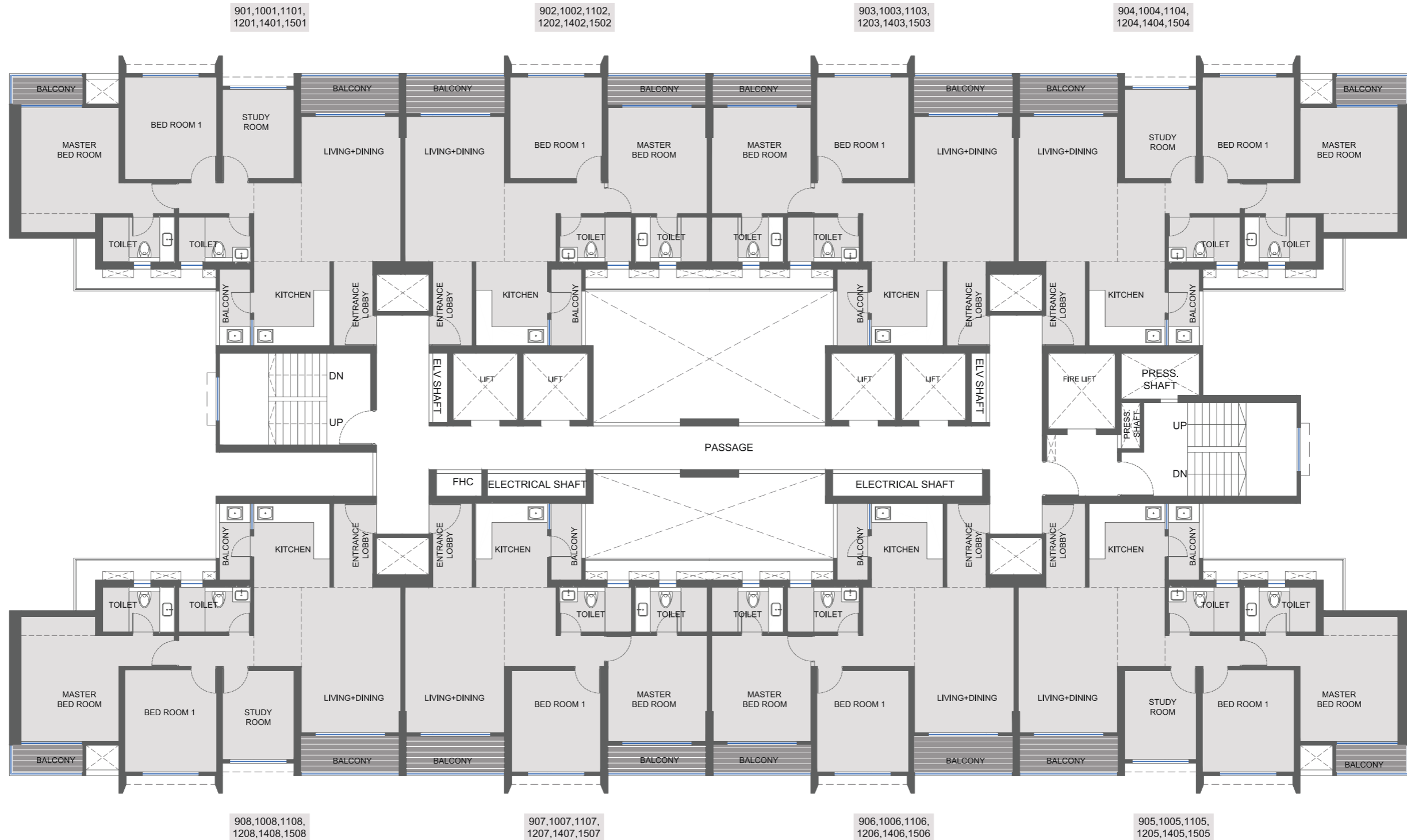

TOWER B
 (9th, 10th, 11th, 12th,
 14th, & 15th Floor
 Plan)

UNIT TYPE	FLAT NUMBERS	FLAT CARPET AREA (SQ.M.)	FLAT CARPET AREA (SQ.FT.)	BALCONY AREA (SQ.M.)	BALCONY AREA (SQ.FT.)
2.5 BHK MEMORIA	901, 1001, 1101, 1201, 1401, 1501, 904, 1004, 1104, 1204, 1404, 1504 905, 1005, 1105, 1205, 1405, 1505, 908, 1008, 1108, 1208, 1408, 1508	82.99	893.30	9.05	97.41
2 BHK MOMENT	902, 1002, 1102, 1202, 1402, 1502, 903, 1003, 1103, 1203, 1403, 1503	70.09	754.45	9.96	107.21
2 BHK MOMENT	906, 1006, 1106, 1206, 1406, 1506, 907, 1007, 1107, 1207, 1407, 1507	70.09	754.45	9.96	107.21

- All Dimensions Are In Meter Unless Otherwise Specified
- Dimensions & Areas Additionally Mentioned in Feet Inches & Square Feet Are Only For Customer's Understanding. Kindly Do Not Refer The Same For Any RERA Related Reference.





TOWER B
(13th Refuge
Floor Plan)

UNIT TYPE	FLAT NUMBERS	FLAT CARPET AREA (SQ.M.)	FLAT CARPET AREA (SQ.FT.)	BALCONY AREA (SQ.M.)	BALCONY AREA (SQ.FT.)
2.5 BHK MEMORIA	1301, 1304, 1305, 1308	82.99	893.30	9.05	97.41
2 BHK MOMENT	1302, 1303	70.09	754.45	9.96	107.21
2.5 BHK MEMORIA (REFUGE)	1306	87.75	944.54	13.06	140.58

1. All Dimensions Are In Meter Unless Otherwise Specified
2. Dimensions & Areas Additionally Mentioned in Feet Inches & Square Feet Are Only For Customer's Understanding. Kindly Do Not Refer The Same For Any RERA Related Reference.



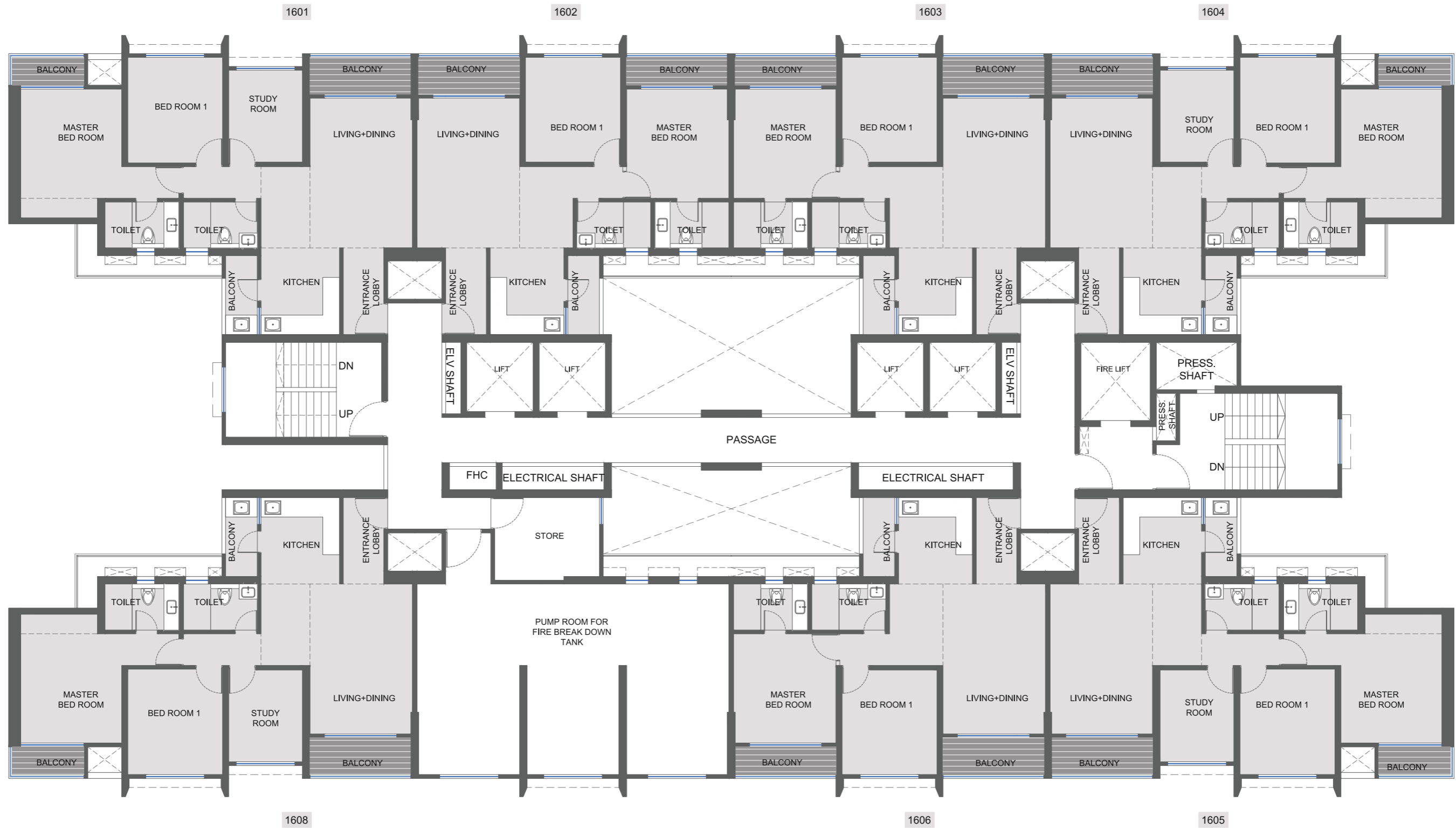

TOWER B
(16th Floor Plan)

UNIT TYPE	FLAT NUMBERS	FLAT CARPET AREA (SQ.M.)	FLAT CARPET AREA (SQ.FT.)	BALCONY AREA (SQ.M.)	BALCONY AREA (SQ.FT.)
2.5 BHK MEMORIA	1601, 1604, 1605, 1608	82.99	893.30	9.05	97.41
2 BHK MOMENT	1602, 1603, 1606	70.09	754.45	9.96	107.21

1. All Dimensions Are In Meter Unless Otherwise Specified
2. Dimensions & Areas Additionally Mentioned in Feet Inches & Square Feet Are Only For Customer's Understanding. Kindly Do Not Refer The Same For Any RERA Related Reference.

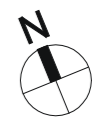

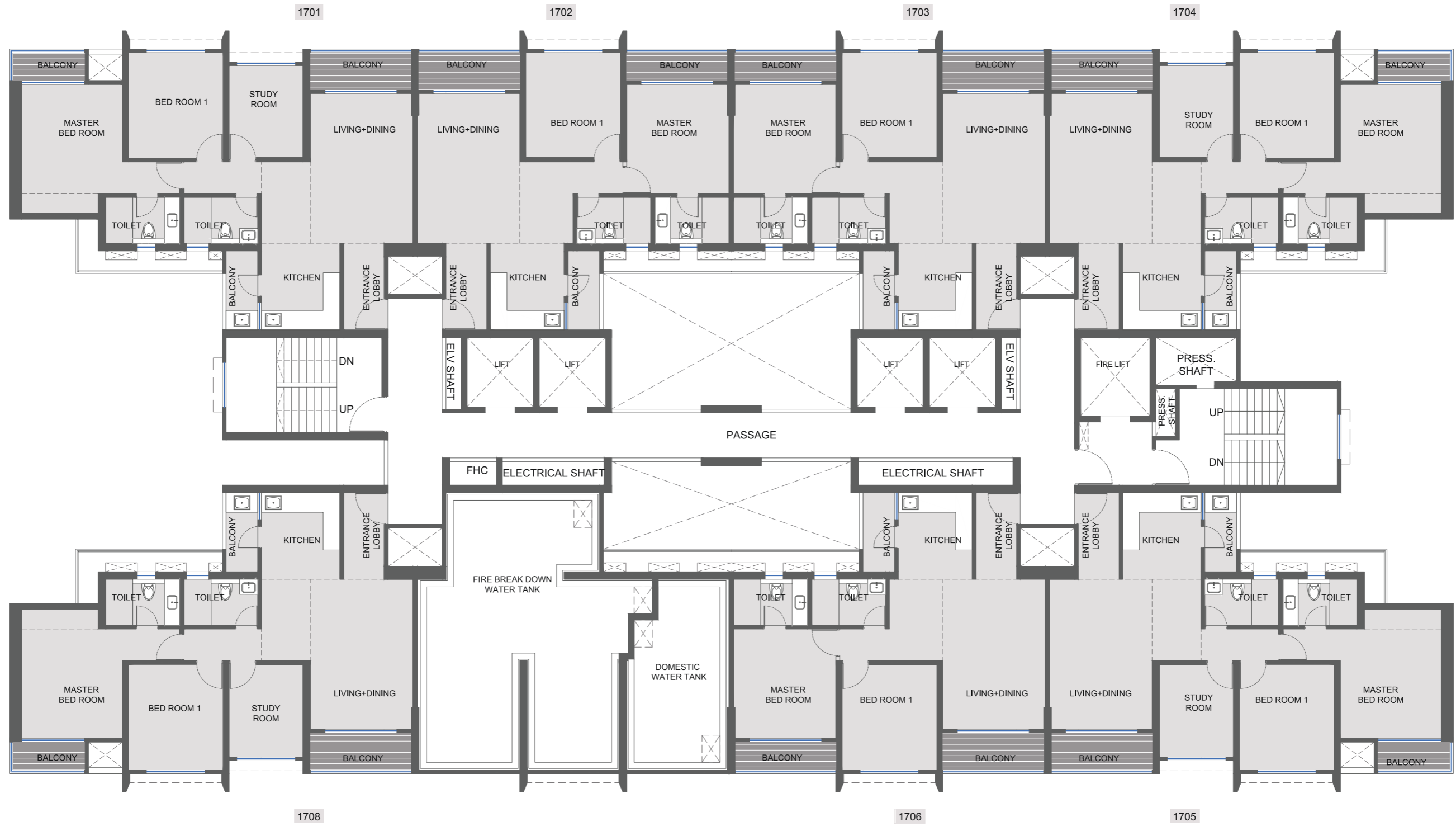

TOWER B
(17th Floor Plan)

UNIT TYPE	FLAT NUMBERS	FLAT CARPET AREA (SQ.M.)	FLAT CARPET AREA (SQ.FT.)	BALCONY AREA (SQ.M.)	BALCONY AREA (SQ.FT.)
2.5 BHK MEMORIA	1701, 1704, 1705, 1708	82.99	893.30	9.05	97.41
2 BHK MOMENT	1702, 1703, 1706	70.09	754.45	9.96	107.21

1. All Dimensions Are In Meter Unless Otherwise Specified
2. Dimensions & Areas Additionally Mentioned in Feet Inches & Square Feet Are Only For Customer's Understanding. Kindly Do Not Refer The Same For Any RERA Related Reference.





TOWER B
(18th Refuge
Floor Plan)

UNIT TYPE	FLAT NUMBERS	FLAT CARPET AREA (SQ.M.)	FLAT CARPET AREA (SQ.FT.)	BALCONY AREA (SQ.M.)	BALCONY AREA (SQ.FT.)
2.5 BHK MEMORIA	1801, 1804, 1805, 1808	82.99	893.30	9.05	97.41
2 BHK MOMENT	1802, 1803, 1806	70.09	754.45	9.96	107.21

1. All Dimensions Are In Meter Unless Otherwise Specified
2. Dimensions & Areas Additionally Mentioned in Feet Inches & Square Feet Are Only For Customer's Understanding. Kindly Do Not Refer The Same For Any RERA Related Reference.



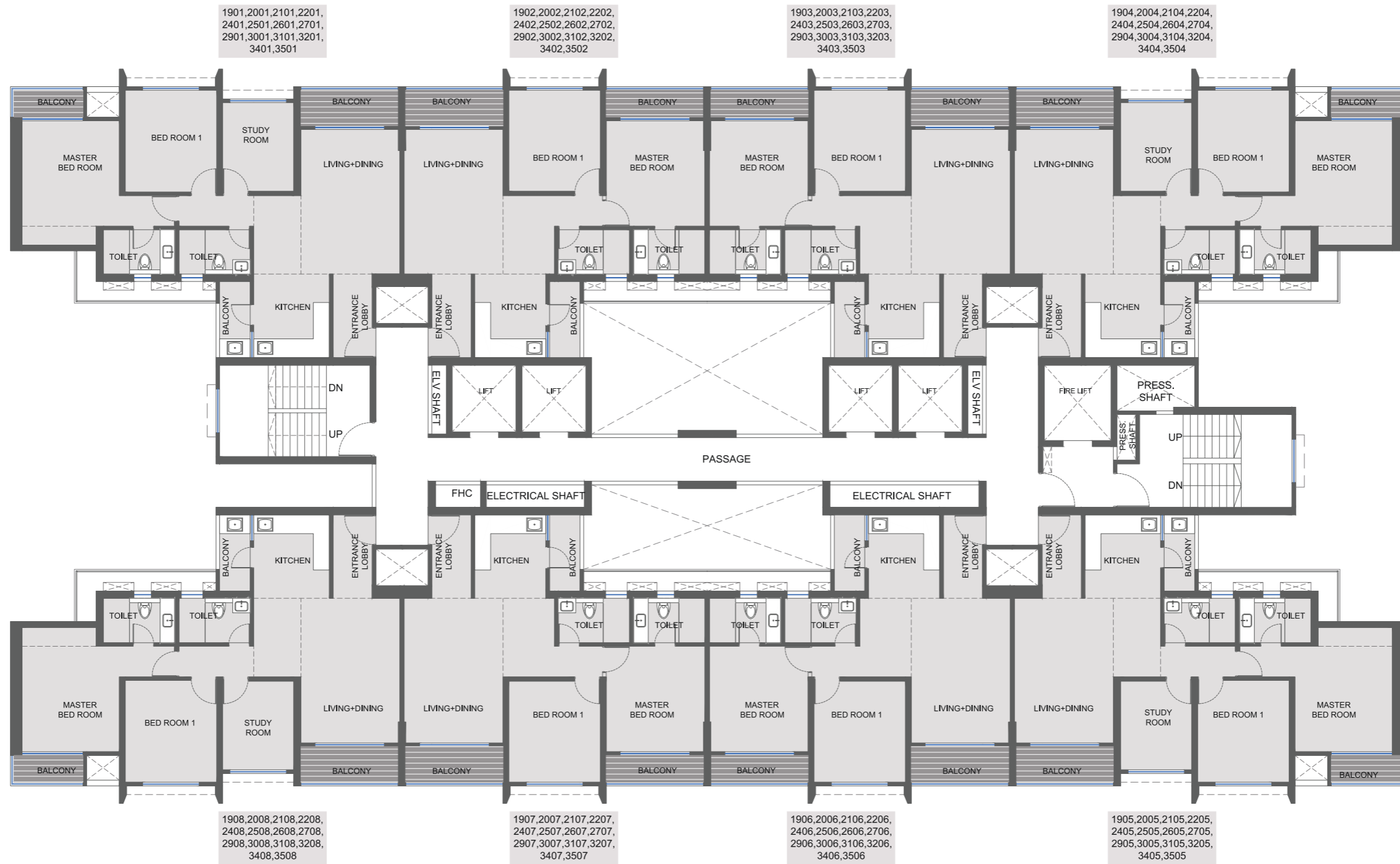

TOWER B

(19th, 20th, 21st, 22nd,
24th, 25th, 26th, 27th,
29th, 30th, 31st, 32nd,
34th, & 35th Floor
Plan)

UNIT TYPE	FLAT NUMBERS	FLAT CARPET AREA (SQ.M.)	FLAT CARPET AREA (SQ.FT.)	BALCONY AREA (SQ.M.)	BALCONY AREA (SQ.FT.)
2.5 BHK MEMORIA	1901, 2001, 2101, 2201, 2401, 2501, 2601, 2701, 2901, 3001, 3101, 3201, 3401, 3501, 1904, 2004, 2104, 2204, 2404, 2504, 2604, 2704, 2904, 3004, 3104, 3204, 3404, 3504, 1905, 2005, 2105, 2205, 2405, 2505, 2605, 2705, 2905, 3005, 3105, 3205, 3405, 3505, 1908, 2008, 2108, 2208, 2408, 2508, 2608, 2708, 2908, 3008, 3108, 3208, 3408, 3508.	82.99	893.30	9.05	97.41
2 BHK MOMENT	1902, 2002, 2102, 2202, 2402, 2502, 2602, 2702, 2902, 3002, 3102, 3202, 3402, 3502, 1903, 2003, 2103, 2203, 2403, 2503, 2603, 2703, 2903, 3003, 3103, 3203, 3403, 3503, 1906, 2006, 2106, 2206, 2406, 2506, 2606, 2706, 2906, 3006, 3106, 3206, 3406, 3506, 1907, 2007, 2107, 2207, 2407, 2507, 2607, 2707, 2907, 3007, 3107, 3207, 3407, 3507.	70.09	754.45	9.96	107.21

- All Dimensions Are In Meter Unless Otherwise Specified
- Dimensions & Areas Additionally Mentioned in Feet Inches & Square Feet Are Only For Customer's Understanding. Kindly Do Not Refer The Same For Any RERA Related Reference.

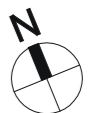

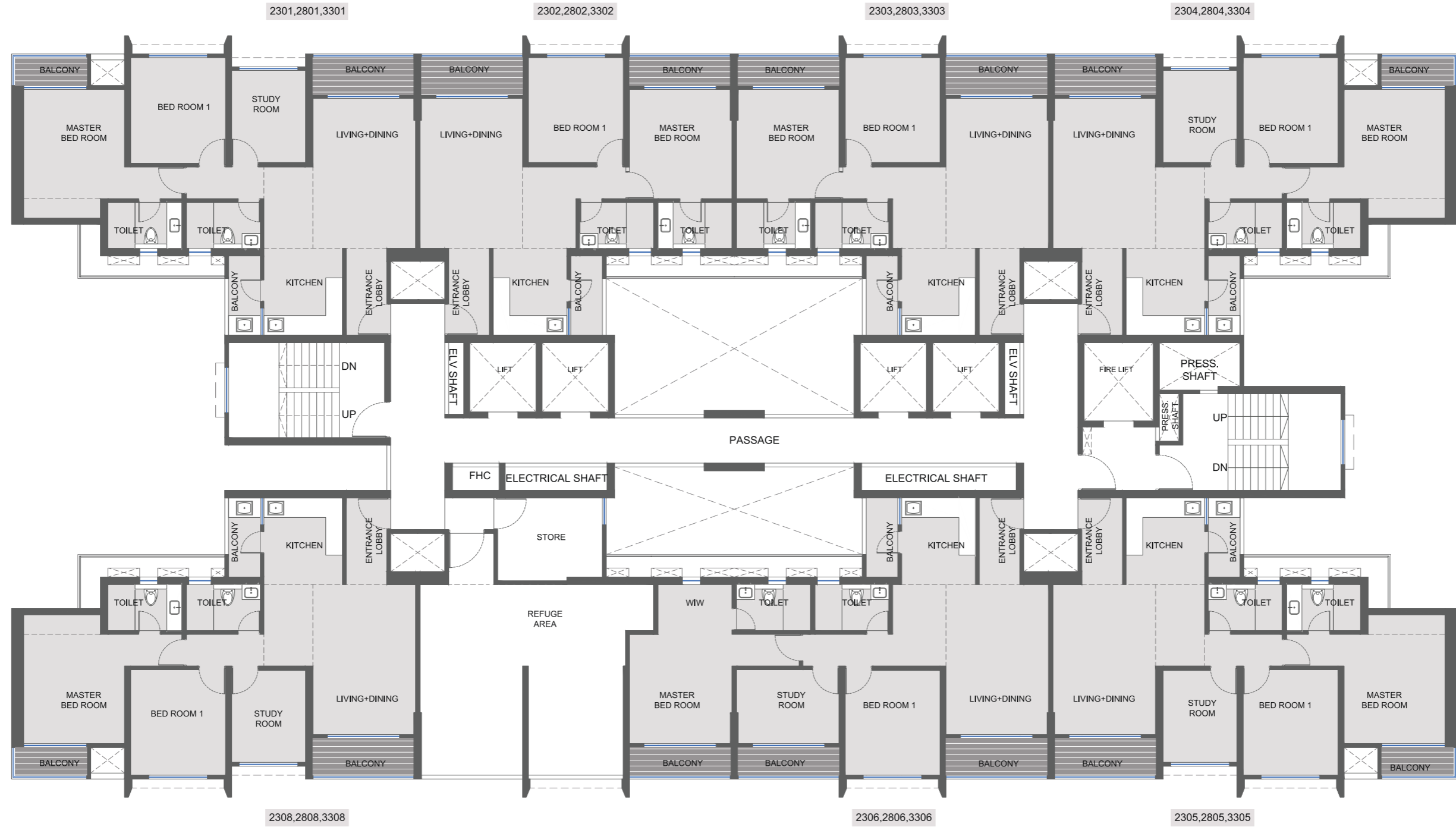

TOWER B
 (23rd, 28th & 33rd
 Refuge Floor
 Plan)

UNIT TYPE	FLAT NUMBERS	FLAT CARPET AREA (SQ.M.)	FLAT CARPET AREA (SQ.FT.)	BALCONY AREA (SQ.M.)	BALCONY AREA (SQ.FT.)
2.5 BHK MEMORIA	2301, 2801, 3301, 2304, 2804, 3304, 2305, 2805, 3305 2308, 2808, 3308.	82.99	893.30	9.05	97.41
2 BHK MOMENT	2302, 2802, 3302, 2303, 2803, 3303.	70.09	754.45	9.96	107.21
2.5 BHK MEMORIA (REFUGE)	2306, 2806, 3306	87.75	944.54	13.06	140.58

- All Dimensions Are In Meter Unless Otherwise Specified
- Dimensions & Areas Additionally Mentioned in Feet Inches & Square Feet Are Only For Customer's Understanding. Kindly Do Not Refer The Same For Any RERA Related Reference.





UNIT PLAN

TOWER B

TOWER B

2.5 BHK MEMORIA + PRIVATE TERRACE

Flat Carpet Area (Sq.m./Sq.ft) :	82.77 / 890.94
Balcony Area (Sq.m./Sq.ft) :	10.01 / 107.75
Private Terrace Area (Sq.m./Sq.ft) :	36.95 / 397.73

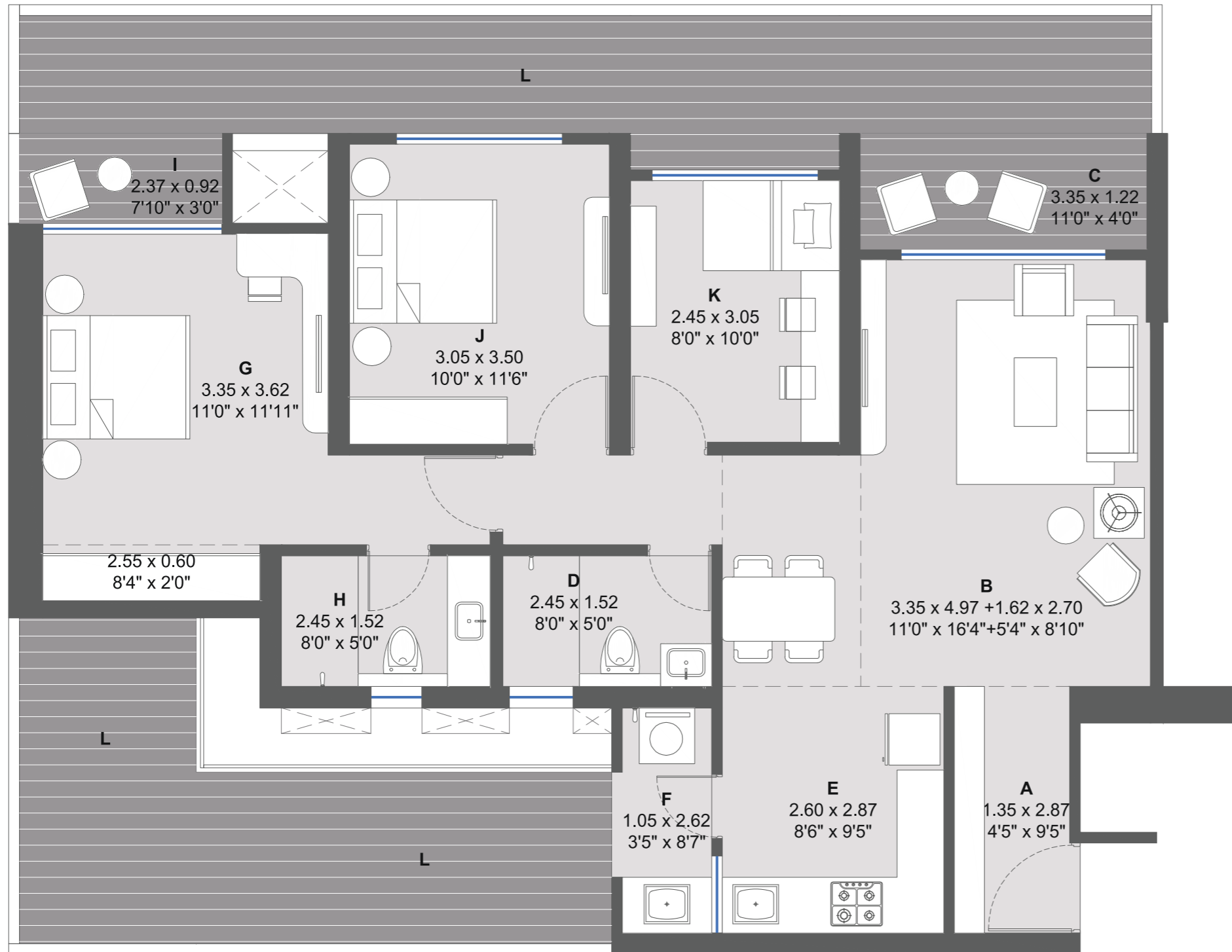

LIVING SPACE

- A. ENTRANCE LOBBY
- B. LIVING + DINING
- C. BALCONY
- D. TOILET

KITCHEN SPACE

- E. KITCHEN
- F. BALCONY

BEDROOMS

- G. MASTER BEDROOM
- H. TOILET
- I. BALCONY
- J. BEDROOM 01
- K. STUDY ROOM
- L. PRIVATE TERRACE

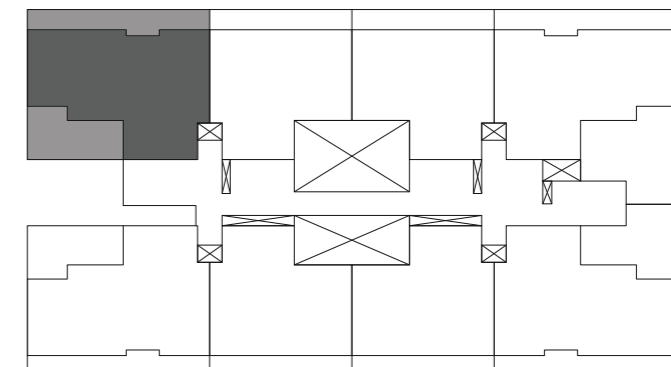

FIRST FLOOR - FLAT NO. 101

1. All Dimensions Are In Meter Unless Otherwise Specified
2. Dimensions & Areas Additionally Mentioned in Feet Inches & Square Feet Are Only For Customer's Understanding. Kindly Do Not Refer The Same For Any RERA Related Reference.



TOWER B

2 BHK MOMENT + PRIVATE TERRACE

Flat Carpet Area (Sq.m./Sq.ft):	70.09 / 754.45
Balcony Area (Sq.m./Sq.ft):	10.80 / 116.25
Private Terrace Area (Sq.m./Sq.ft):	14.26 / 153.49

LIVING SPACE

- A. ENTRANCE LOBBY
- B. LIVING + DINING
- C. BALCONY
- D. TOILET

BEDROOMS

- G. MASTER BEDROOM
- H. TOILET
- I. BALCONY
- J. BEDROOM 01
- K. PRIVATE TERRACE

KITCHEN SPACE

- E. KITCHEN
- F. BALCONY

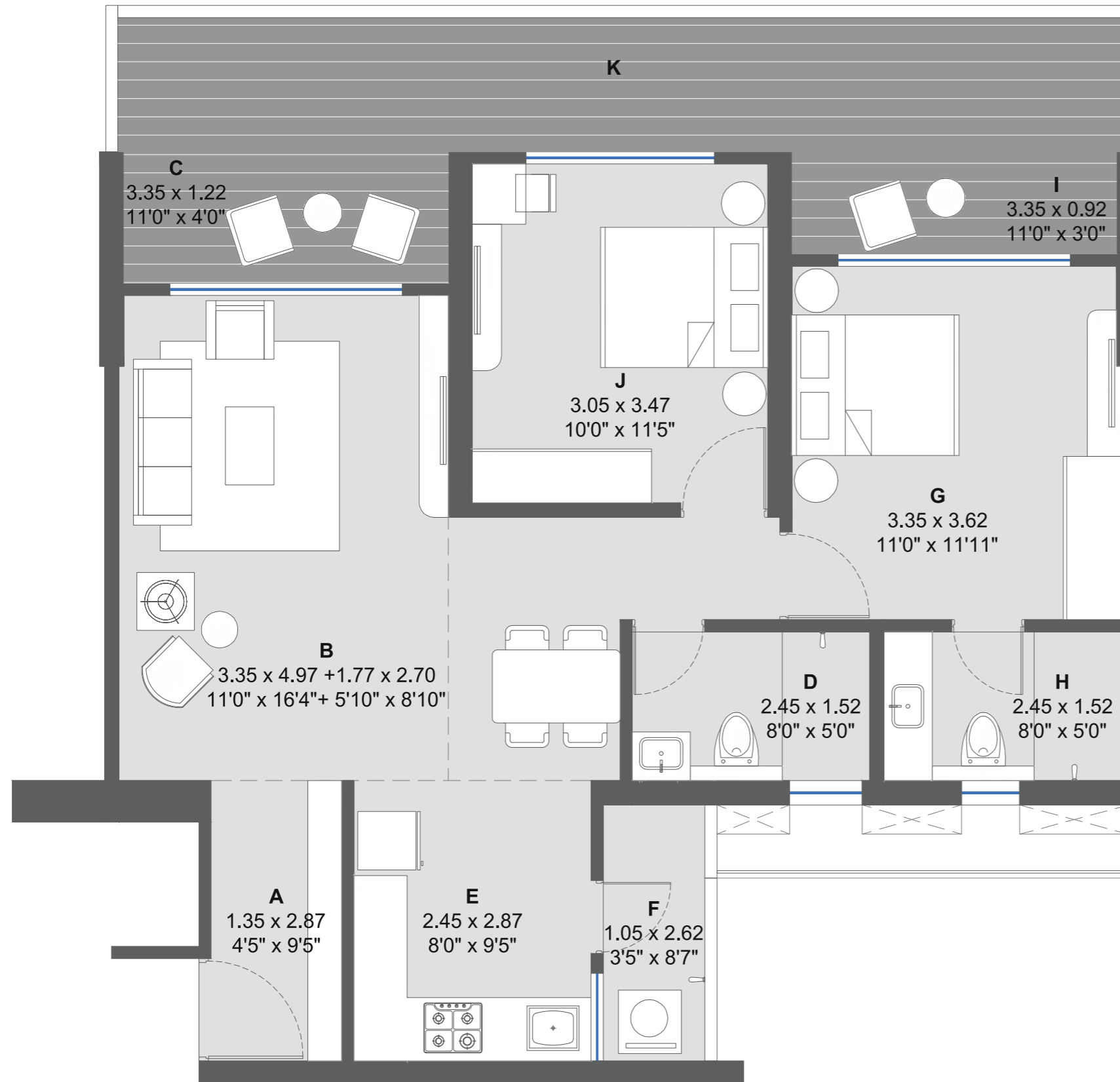
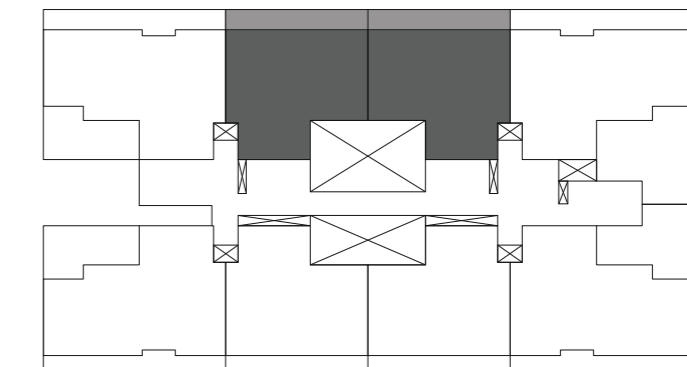

FIRST FLOOR - FLAT NO. 102/103

1. All Dimensions Are In Meter Unless Otherwise Specified
2. Dimensions & Areas Additionally Mentioned in Feet Inches & Square Feet Are Only For Customer's Understanding. Kindly Do Not Refer The Same For Any RERA Related Reference.



TOWER B

2.5 BHK MEMORIA + PRIVATE TERRACE

Flat Carpet Area (Sq.m./Sq.ft) : 82.77 / 890.94
 Balcony Area (Sq.m./Sq.ft) : 10.01 / 107.75
 Private Terrace Area (Sq.m./Sq.ft) : 54.32 / 584.70

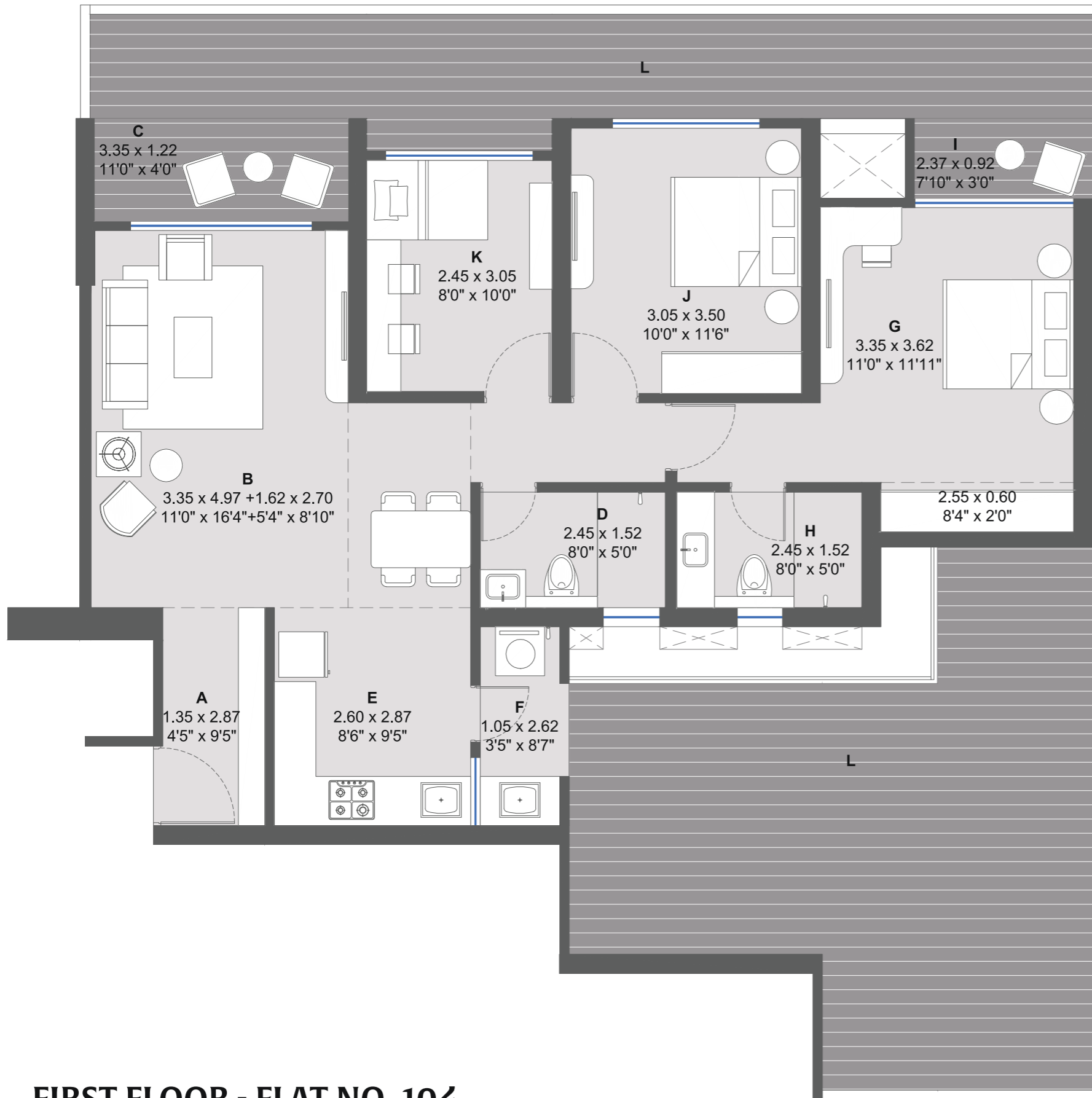

LIVING SPACE

- A. ENTRANCE LOBBY
- B. LIVING + DINING
- C. BALCONY
- D. TOILET

KITCHEN SPACE

- E. KITCHEN
- F. BALCONY

BEDROOMS

- G. MASTER BEDROOM
- H. TOILET
- I. BALCONY
- J. BEDROOM 01
- K. STUDY ROOM
- L. PRIVATE TERRACE

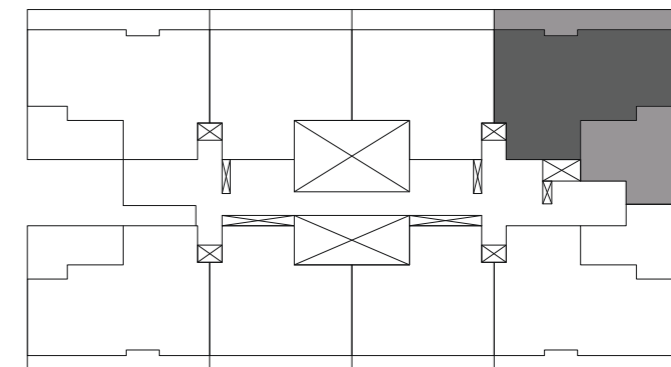

FIRST FLOOR - FLAT NO. 104

1. All Dimensions Are In Meter Unless Otherwise Specified
2. Dimensions & Areas Additionally Mentioned in Feet Inches & Square Feet Are Only For Customer's Understanding. Kindly Do Not Refer The Same For Any RERA Related Reference.



TOWER B

2.5 BHK MEMORIA + PRIVATE TERRACE

Flat Carpet Area (Sq.m./Sq.ft): 82.77 / 890.94
 Balcony Area (Sq.m./Sq.ft): 10.01 / 107.75
 Private Terrace Area (Sq.m./Sq.ft): 37.53 / 403.97

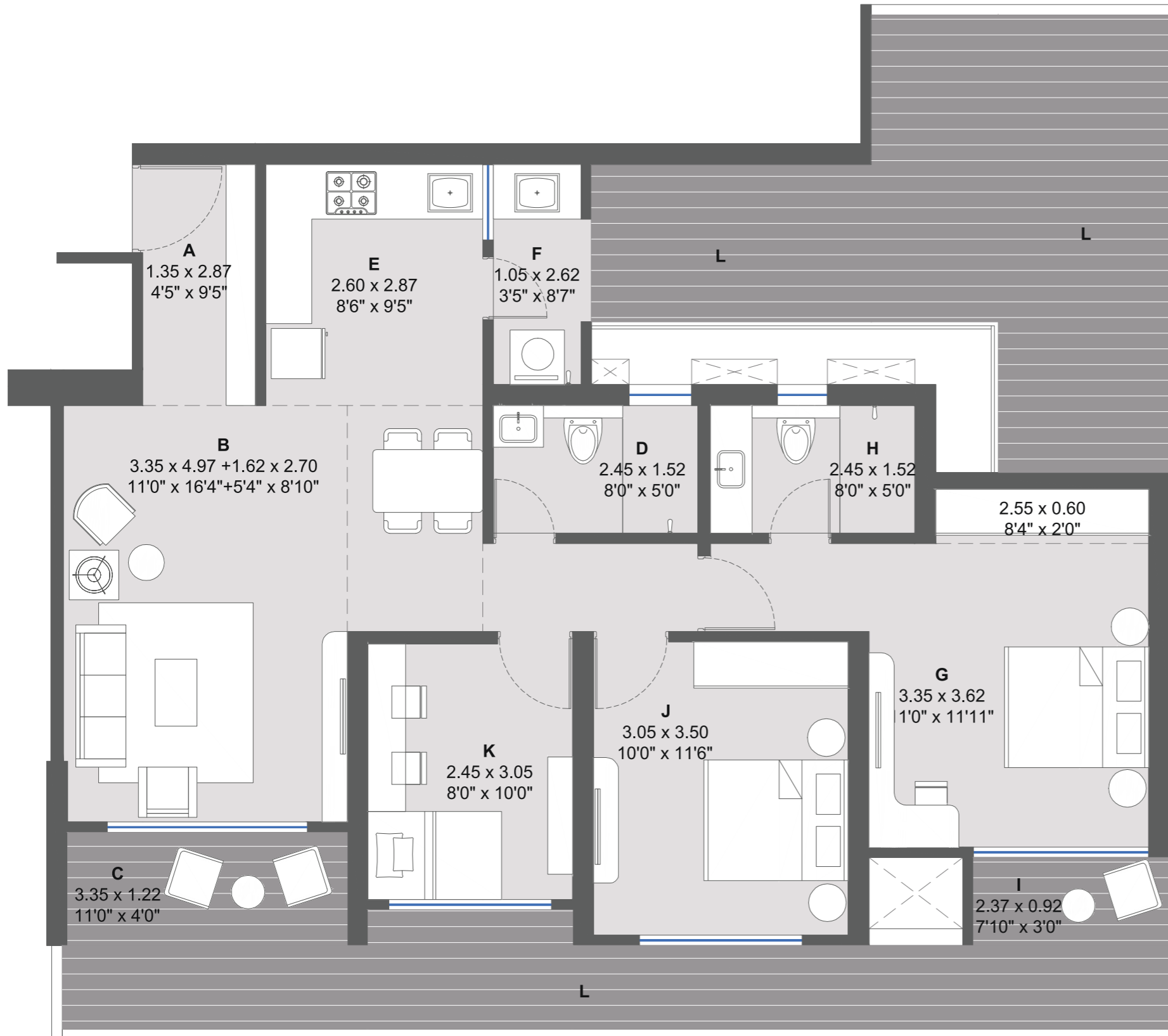

LIVING SPACE

- A. ENTRANCE LOBBY
- B. LIVING + DINING
- C. BALCONY
- D. TOILET

KITCHEN SPACE

- E. KITCHEN
- F. BALCONY

BEDROOMS

- G. MASTER BEDROOM
- H. TOILET
- I. BALCONY
- J. BEDROOM 01
- K. STUDY ROOM
- L. PRIVATE TERRACE

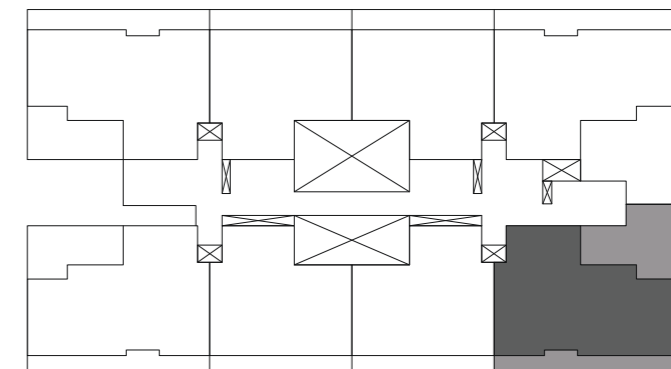

FIRST FLOOR - FLAT NO. 105

1. All Dimensions Are In Meter Unless Otherwise Specified
2. Dimensions & Areas Additionally Mentioned in Feet Inches & Square Feet Are Only For Customer's Understanding. Kindly Do Not Refer The Same For Any RERA Related Reference.



TOWER B

2 BHK MOMENT + PRIVATE TERRACE

Flat Carpet Area (Sq.m./Sq.ft):	70.09 / 754.45
Balcony Area (Sq.m./Sq.ft):	10.80 / 116.25
Private Terrace Area (Sq.m./Sq.ft):	10.37 / 111.62

LIVING SPACE

- A. ENTRANCE LOBBY
- B. LIVING + DINING
- C. BALCONY
- D. TOILET

BEDROOMS

- G. MASTER BEDROOM
- H. TOILET
- I. BALCONY
- J. BEDROOM 01
- K. PRIVATE TERRACE

KITCHEN SPACE

- E. KITCHEN
- F. BALCONY

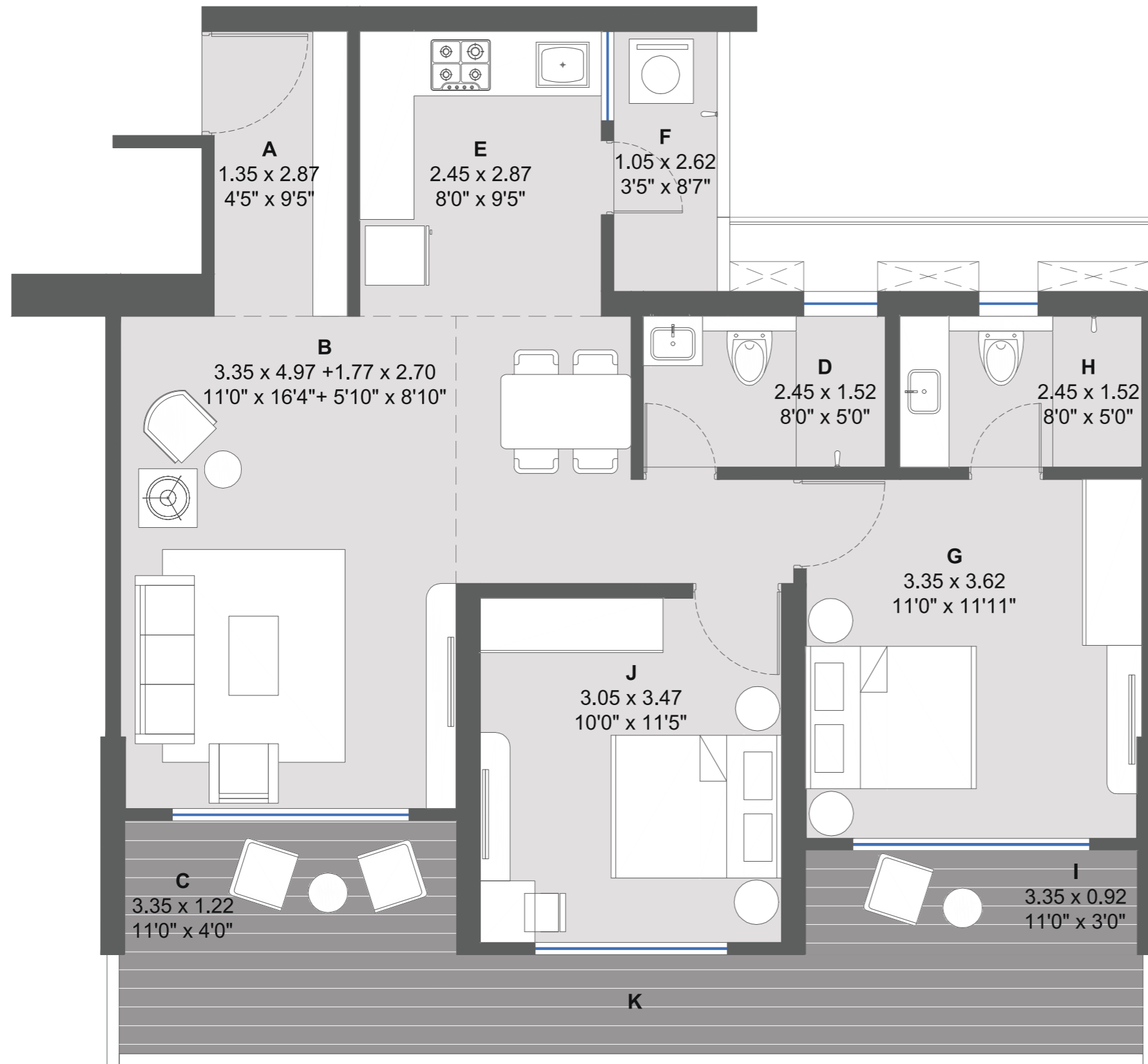
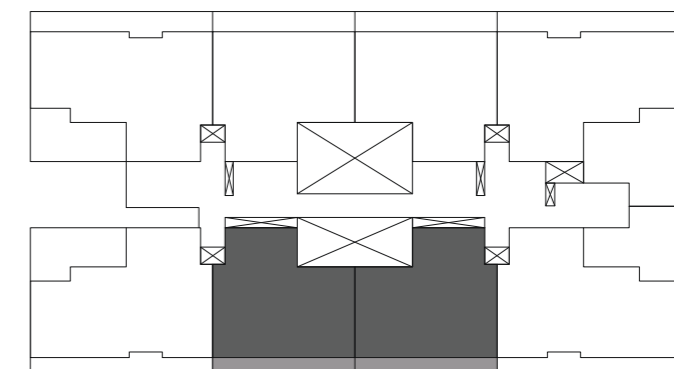

FIRST FLOOR - FLAT NO. 106/107

1. All Dimensions Are In Meter Unless Otherwise Specified
2. Dimensions & Areas Additionally Mentioned in Feet Inches & Square Feet Are Only For Customer's Understanding. Kindly Do Not Refer The Same For Any RERA Related Reference.



TOWER B

2.5 BHK MEMORIA + PRIVATE TERRACE

Flat Carpet Area (Sq.m./Sq.ft) :	82.77 / 890.94
Balcony Area (Sq.m./Sq.ft) :	10.01 / 107.75
Private Terrace Area (Sq.m./Sq.ft) :	31.96 / 344.02



LIVING SPACE

- A. ENTRANCE LOBBY
- B. LIVING + DINING
- C. BALCONY
- D. TOILET

KITCHEN SPACE

- E. KITCHEN
- F. BALCONY

BEDROOMS

- G. MASTER BEDROOM
- H. TOILET
- I. BALCONY
- J. BEDROOM 01
- K. STUDY ROOM
- L. PRIVATE TERRACE

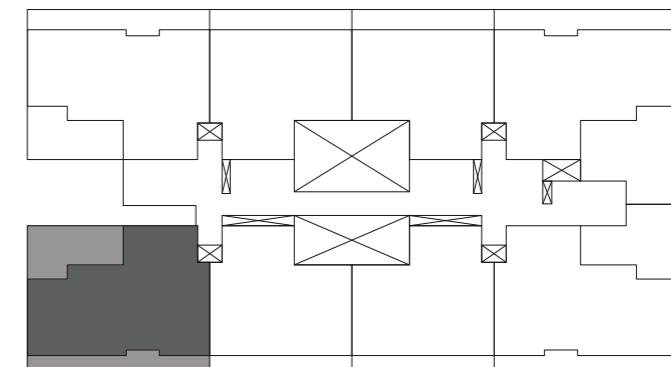

FIRST FLOOR - FLAT NO. 108

1. All Dimensions Are In Meter Unless Otherwise Specified
2. Dimensions & Areas Additionally Mentioned in Feet Inches & Square Feet Are Only For Customer's Understanding. Kindly Do Not Refer The Same For Any RERA Related Reference.



TOWER B

2.5 BHK MEMORIA

Flat Carpet Area (Sq.m./Sq.ft) : 82.77 / 890.94
 Balcony Area (Sq.m./Sq.ft) : 9.05 / 97.41

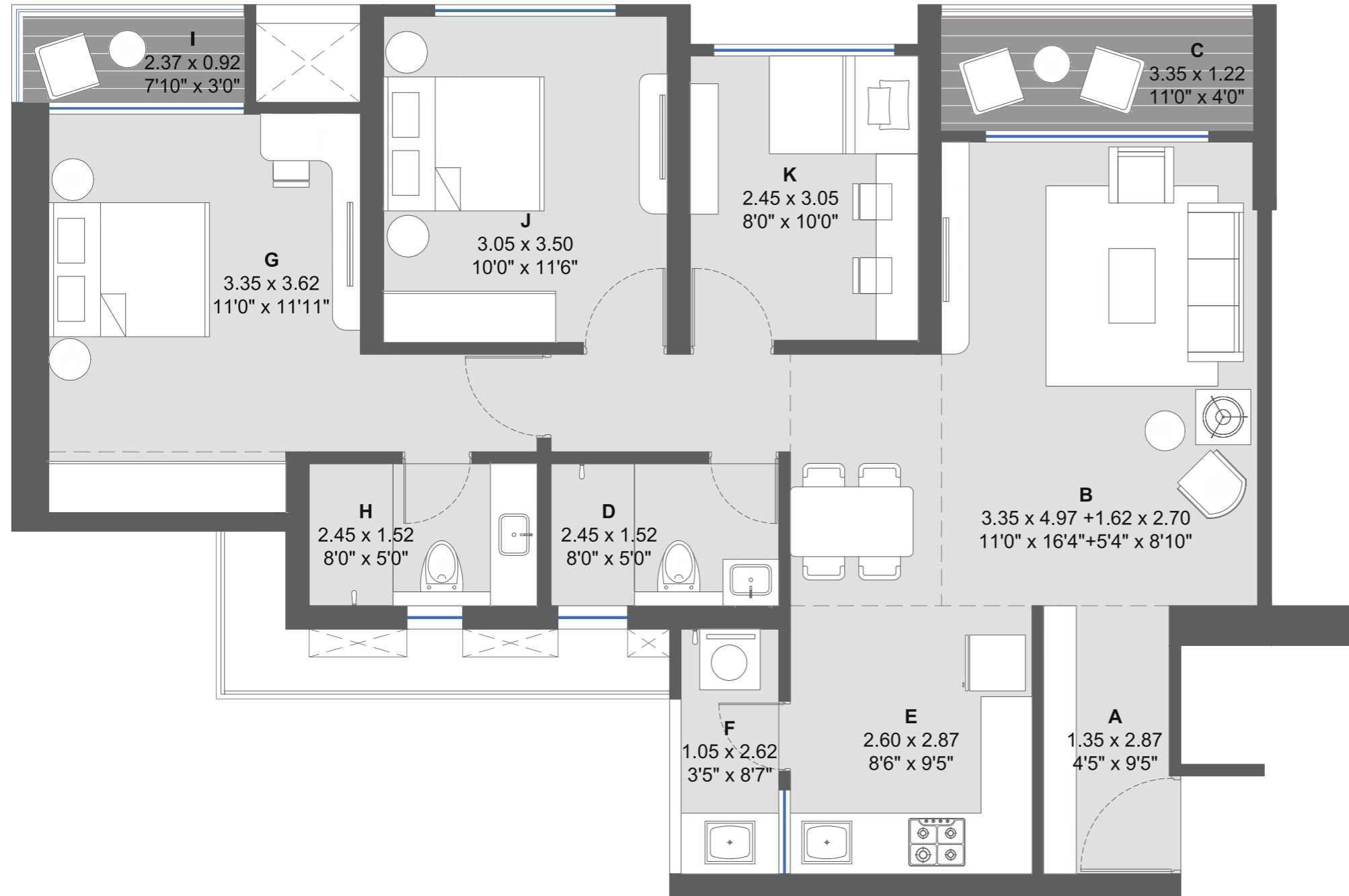

LIVING SPACE

- A. ENTRANCE LOBBY
- B. LIVING + DINING
- C. BALCONY
- D. TOILET

BEDROOMS

- G. MASTER BEDROOM
- H. TOILET
- I. BALCONY
- J. BEDROOM 01
- K. STUDY ROOM

KITCHEN SPACE

- E. KITCHEN
- F. BALCONY

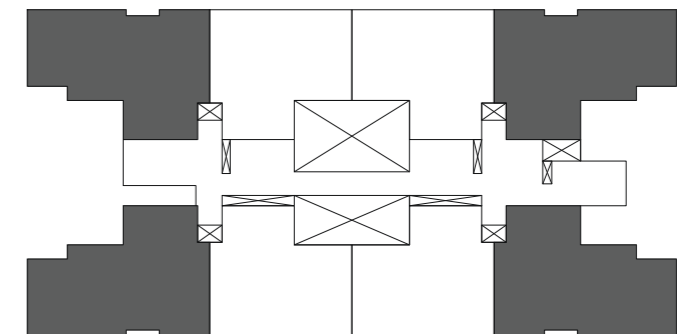

2ND TO 8TH FLOOR - FLAT NO. 01/ 04/ 05/ 08.

1. All Dimensions Are In Meter Unless Otherwise Specified
2. Dimensions & Areas Additionally Mentioned in Feet Inches & Square Feet Are Only For Customer's Understanding. Kindly Do Not Refer The Same For Any RERA Related Reference.



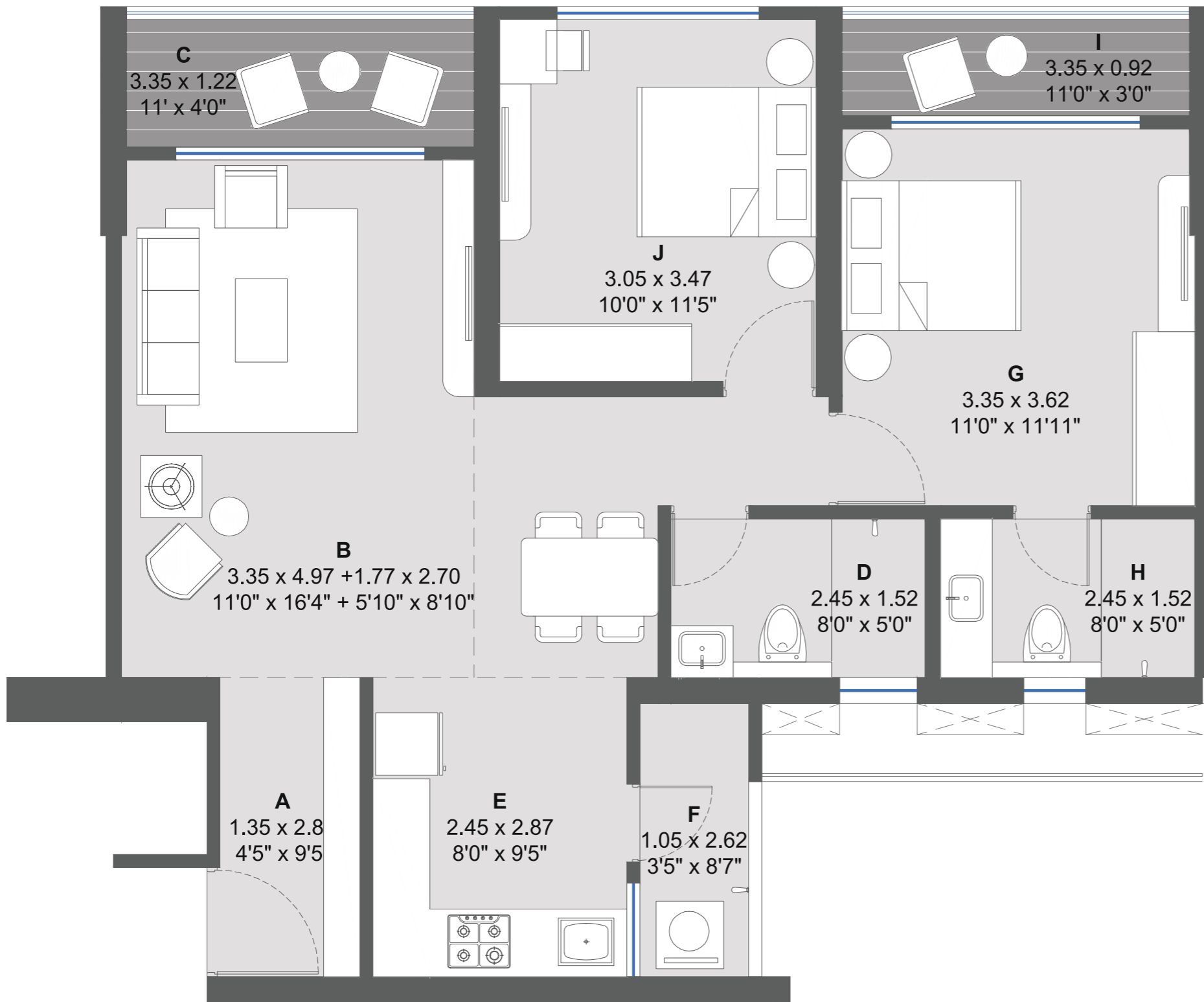

TOWER B

2 BHK MOMENT

Flat Carpet Area (Sq.m./Sq.ft): 70.09 / 890.94
 Balcony Area (Sq.m./Sq.ft): 9.96 / 107.21

LIVING SPACE

- A. ENTRANCE LOBBY
- B. LIVING + DINING
- C. BALCONY
- D. TOILET

BEDROOMS

- G. MASTER BEDROOM
- H. TOILET
- I. BALCONY
- J. BEDROOM 01

KITCHEN SPACE

- E. KITCHEN
- F. BALCONY

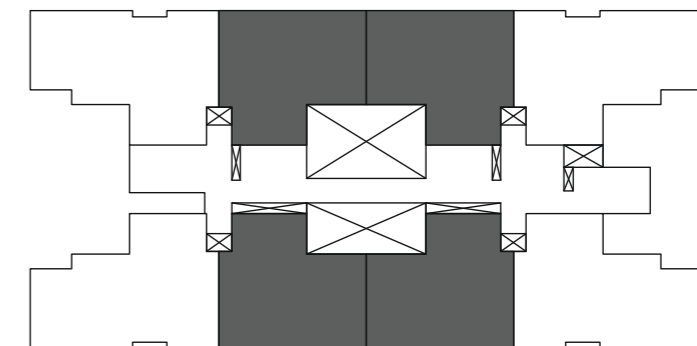

2ND TO 8TH FLOOR - FLAT NO. 02/03

2ND, 4TH TO 7TH FLOOR - FLAT NO. 07/06

1. All Dimensions Are In Meter Unless Otherwise Specified
2. Dimensions & Areas Additionally Mentioned in Feet Inches & Square Feet Are Only For Customer's Understanding. Kindly Do Not Refer The Same For Any RERA Related Reference.



TOWER B

2.5 BHK (REFUGE) MEMORIA + PRIVATE TERRACE

Flat Carpet Area (Sq.m./Sq.ft) : 87.75 / 944.54
 Balcony Area (Sq.m./Sq.ft) : 13.06 / 140.58

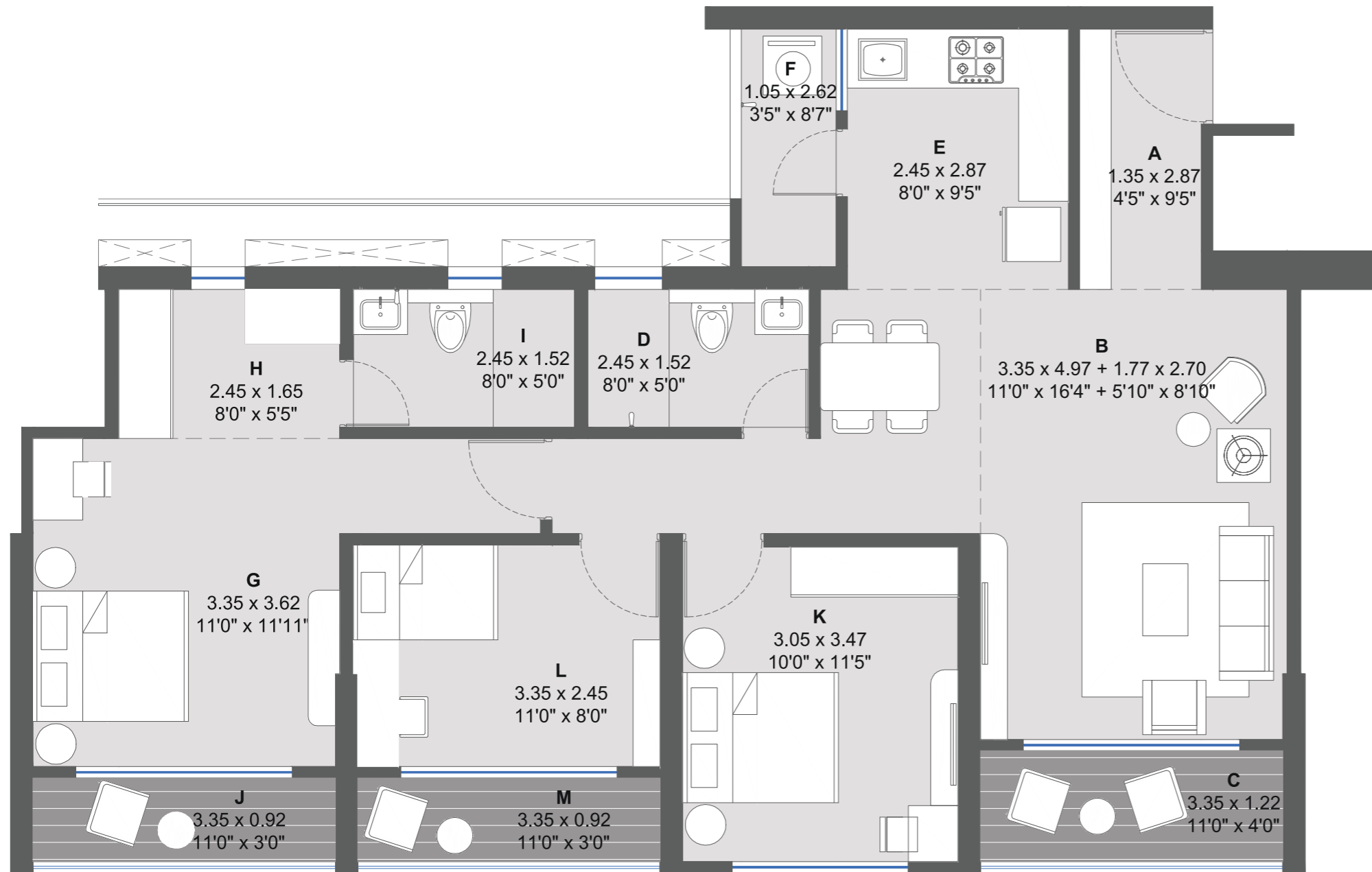

LIVING SPACE

- A. ENTRANCE LOBBY
- B. LIVING + DINING
- C. BALCONY
- D. TOILET

KITCHEN SPACE

- E. KITCHEN
- F. BALCONY

BEDROOMS

- G. MASTER BEDROOM
- H. WALK - IN WARDROBE
- I. TOILET
- J. BALCONY
- K. BEDROOM 01
- L. STUDY ROOM
- M. BALCONY

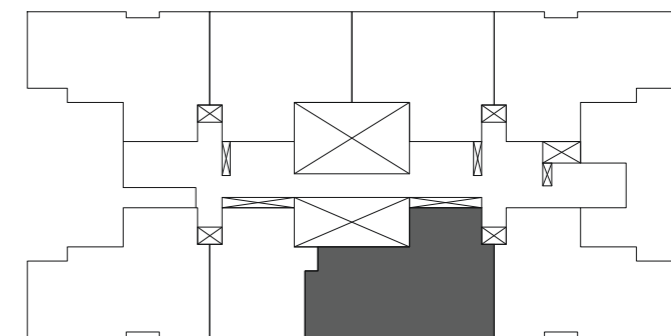

3RD & 8TH FLOOR - FLAT NO. 306/806.

1. All Dimensions Are In Meter Unless Otherwise Specified
2. Dimensions & Areas Additionally Mentioned in Feet Inches & Square Feet Are Only For Customer's Understanding. Kindly Do Not Refer The Same For Any RERA Related Reference.



TOWER B

2.5 BHK MEMORIA

Flat Carpet Area (Sq.m./Sq.ft) : 82.99 / 893.30
 Balcony Area (Sq.m./Sq.ft) : 9.05 / 97.41

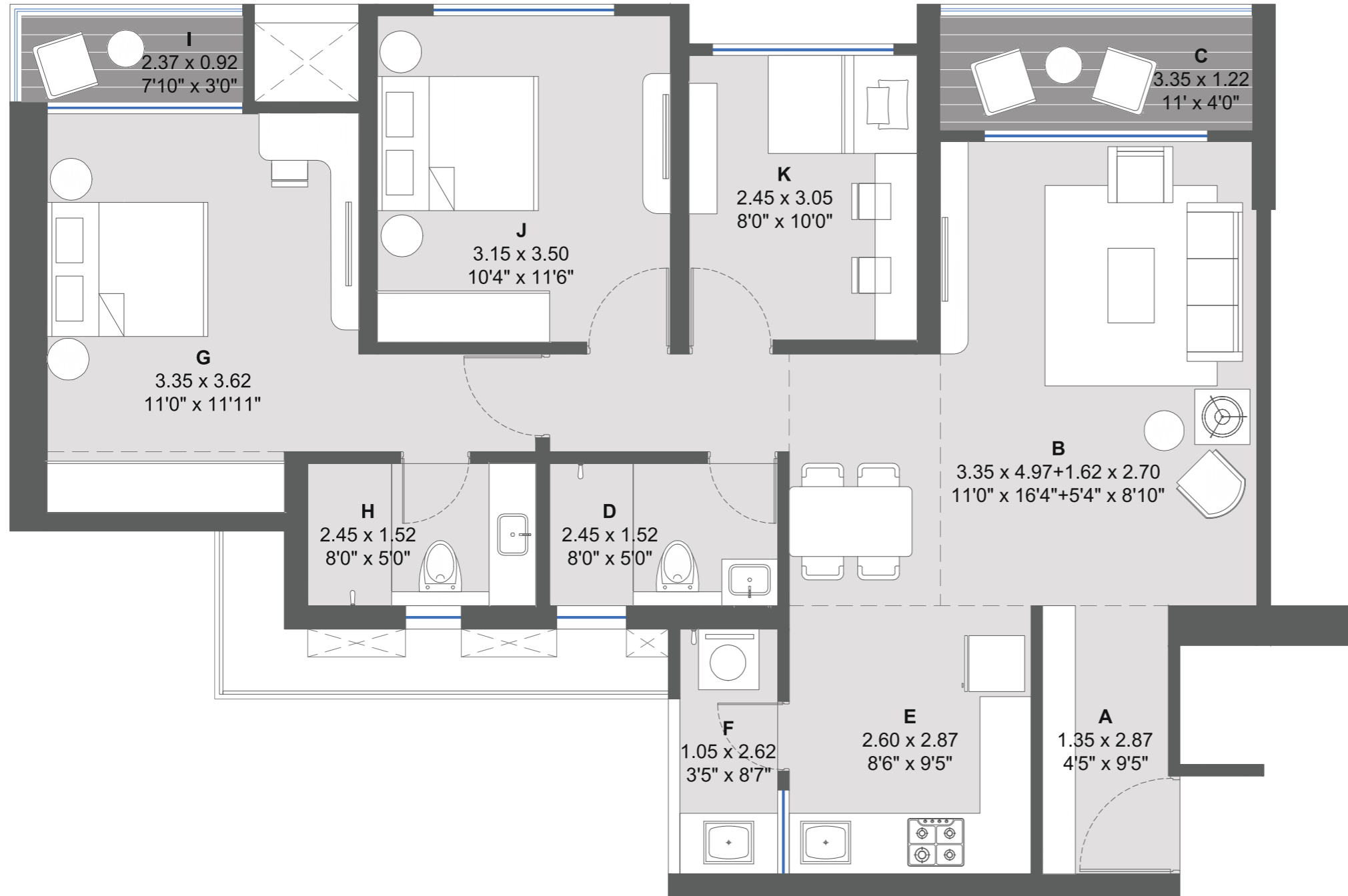

LIVING SPACE

- A. ENTRANCE LOBBY
- B. LIVING + DINING
- C. BALCONY
- D. TOILET

BEDROOMS

- G. MASTER BEDROOM
- H. TOILET
- I. BALCONY
- J. BEDROOM 01
- K. STUDY ROOM

KITCHEN SPACE

- E. KITCHEN
- F. BALCONY

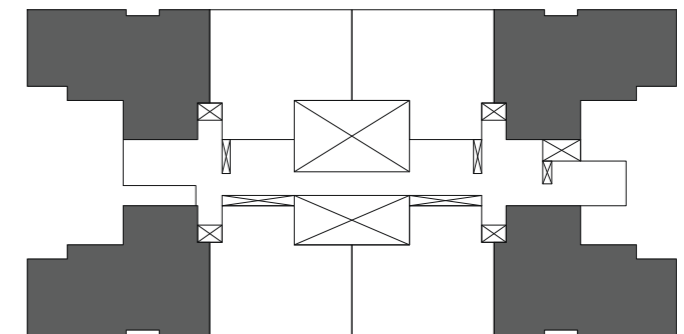

9TH TO 35TH FLOOR - FLAT NO. 01/ 04/ 05/ 08.

- All Dimensions Are In Meter Unless Otherwise Specified
- Dimensions & Areas Additionally Mentioned in Feet Inches & Square Feet Are Only For Customer's Understanding. Kindly Do Not Refer The Same For Any RERA Related Reference.



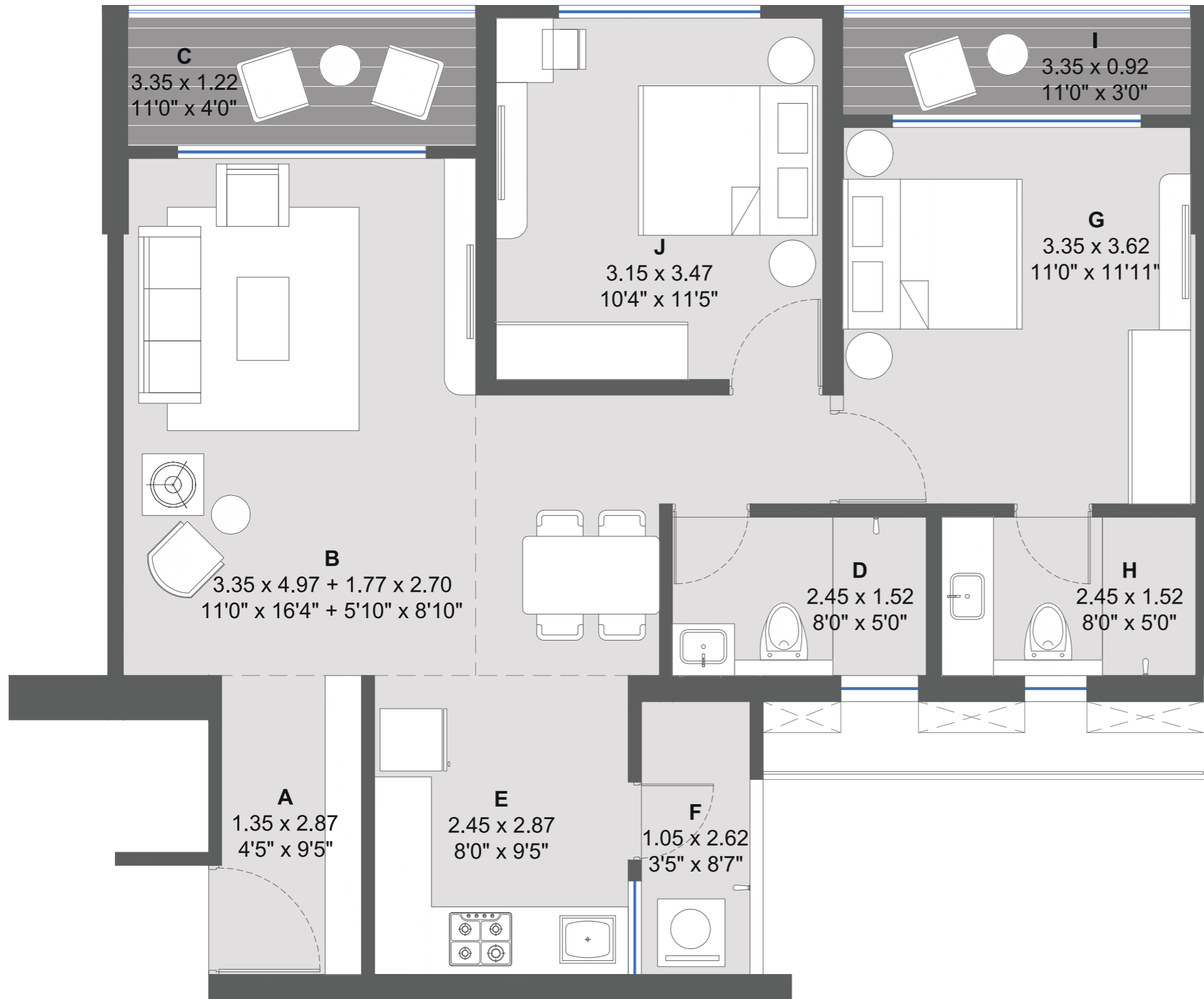

TOWER B

2 BHK MOMENT

Flat Carpet Area (Sq.m./Sq.ft) : 70.09 / 754.45
 Balcony Area (Sq.m./Sq.ft) : 9.96 / 107.21

LIVING SPACE

- A. ENTRANCE LOBBY
- B. LIVING + DINING
- C. BALCONY
- D. TOILET

BEDROOMS

- G. MASTER BEDROOM
- H. TOILET
- I. BALCONY
- J. BEDROOM 01

KITCHEN SPACE

- E. KITCHEN
- F. BALCONY

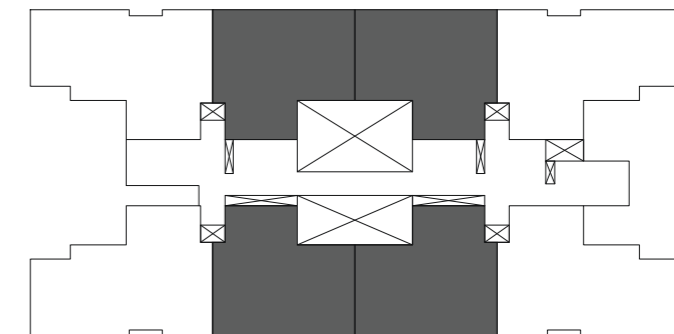

9TH TO 35TH FLOOR - FLAT NO. 02/ 03/ 06.
19TH TO 35TH FLOOR - FLAT NO. 07.

1. All Dimensions Are In Meter Unless Otherwise Specified
2. Dimensions & Areas Additionally Mentioned in Feet Inches & Square Feet Are Only For Customer's Understanding. Kindly Do Not Refer The Same For Any RERA Related Reference.



TOWER B

2.5 BHK MEMORIA (REFUGE)

Flat Carpet Area (Sq.m./Sq.ft) : 87.75 / 944.54
 Balcony Area (Sq.m./Sq.ft) : 13.06 / 140.58

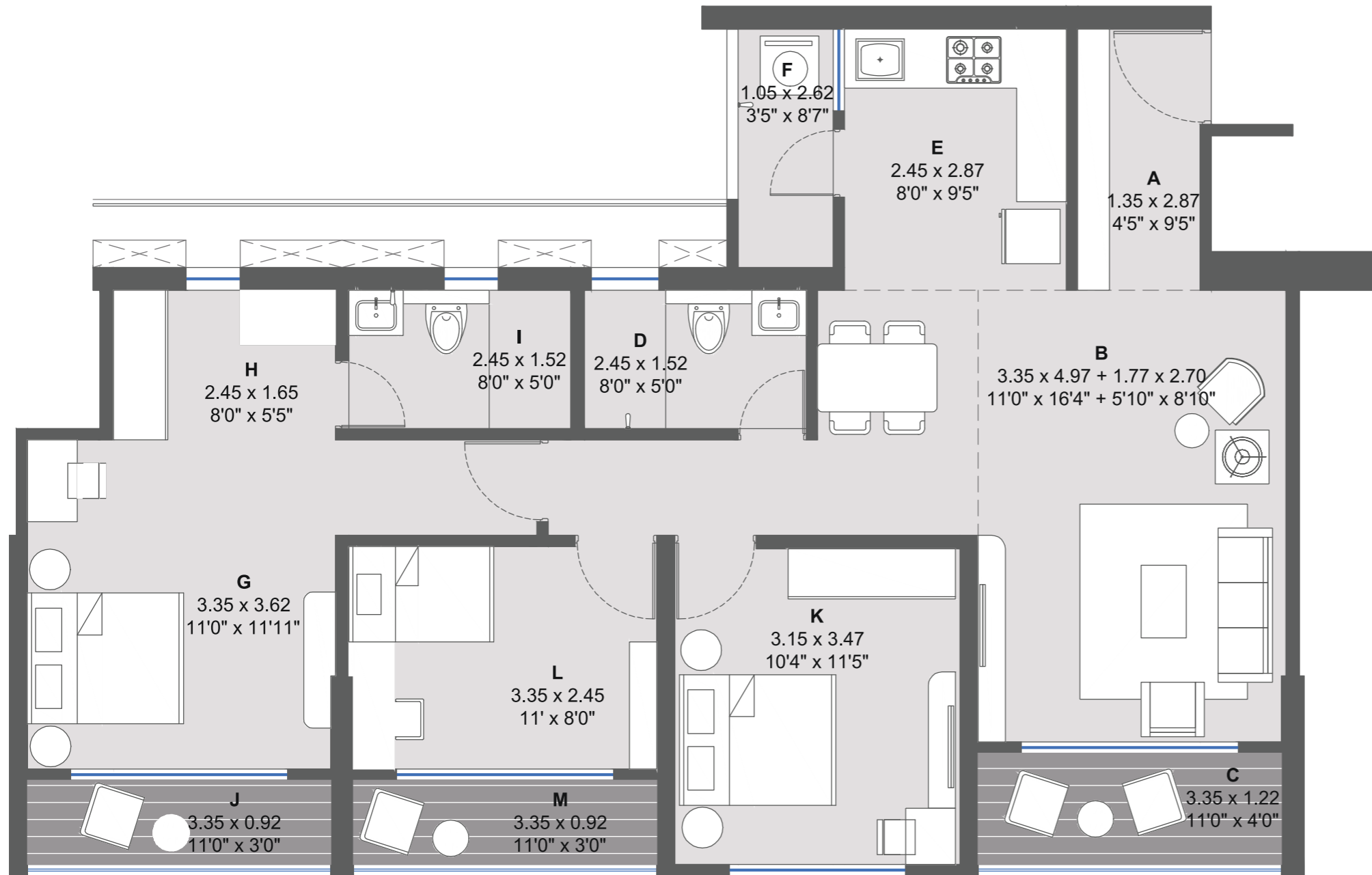

LIVING SPACE

- A. ENTRANCE LOBBY
- B. LIVING + DINING
- C. BALCONY
- D. TOILET

KITCHEN SPACE

- E. KITCHEN
- F. BALCONY

BEDROOMS

- G. MASTER BEDROOM
- H. WALK IN WARDROBE
- I. TOILET
- J. BALCONY
- K. BEDROOM 01
- L. STUDY ROOM
- M. BALCONY

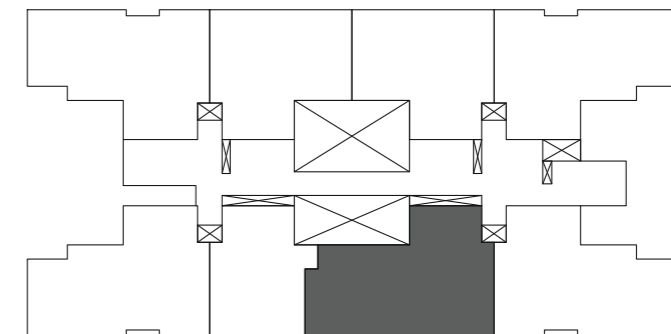

REFUGE FLOOR - FLAT NO. 1306/2306/2806/3306

1. All Dimensions Are In Meter Unless Otherwise Specified
2. Dimensions & Areas Additionally Mentioned in Feet Inches & Square Feet Are Only For Customer's Understanding. Kindly Do Not Refer The Same For Any RERA Related Reference.





FLOOR PLAN

TOWER E



TOWER E
 (1st, 2nd, 3rd, 4th, 5th,
 6th, 7th, 9th, 10th, 11th &
 12th Floor Plan)

UNIT TYPE	FLAT NUMBERS	FLAT CARPET AREA (SQ.M.)	FLAT CARPET AREA (SQ.FT.)	BALCONY AREA (SQ.M.)	BALCONY AREA (SQ.FT.)
2 BHK MOMENT	101, 201, 301, 401, 501, 601, 701, 901, 1001, 1101, 1201, 104, 204, 304, 404, 504, 604, 704, 904, 1004, 1104, 1204, 105, 205, 305, 405, 505, 605, 705, 905, 1005, 1105, 1205, 108, 208, 308, 408, 508, 608, 708, 908, 1008, 1108, 1208.	68.31	735.29	9.49	102.15
2 BHK MOMENT	102, 202, 302, 402, 502, 602, 702, 902, 1002, 1102, 1202, 103, 203, 303, 403, 503, 603, 703, 903, 1003, 1103, 1203, 106, 206, 306, 406, 506, 606, 706, 906, 1006, 1106, 1206, 107, 207, 307, 407, 507, 607, 707, 907, 1007, 1107, 1207.	68.57	738.09	9.49	102.15

- All Dimensions Are In Meter Unless Otherwise Specified
- Dimensions & Areas Additionally Mentioned in Feet Inches & Square Feet Are Only For Customer's Understanding. Kindly Do Not Refer The Same For Any RERA Related Reference.





TOWER E
(8th Refuge
Floor Plan)

UNIT TYPE	FLAT NUMBERS	FLAT CARPET AREA (SQ.M.)	FLAT CARPET AREA (SQ.FT.)	BALCONY AREA (SQ.M.)	BALCONY AREA (SQ.FT.)
2 BHK MOMENT	801, 804, 805, 808	68.31	735.29	9.49	102.15
2 BHK MOMENT	806, 807	68.57	738.09	9.49	102.15
2.5 BHK MEMORIA	803	87.29	939.59	12.38	133.26

1. All Dimentions Are In Meter Unless Otherwise Specified
2. Dimentions & Areas Additionally Mentioned in Feet Inches & Square Feet Are Only For Customer's Understanding. Kindly Do Not Refer The Same For Any RERA Related Reference.

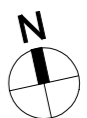



UNIT PLAN

TOWER E

TOWER E

2 BHK MOMENT

Flat Carpet Area (Sq.m./Sq.Ft): 68.31 / 735.29
 Balcony Area (Sq.m./Sq.Ft): 9.49 / 102.15

LIVING SPACE

- A. ENTRANCE LOBBY
- B. LIVING + DINING
- C. BALCONY
- D. TOILET

BEDROOMS

- G. MASTER BEDROOM
- H. TOILET
- I. BALCONY
- J. BEDROOM 01

KITCHEN SPACE

- E. KITCHEN
- F. BALCONY

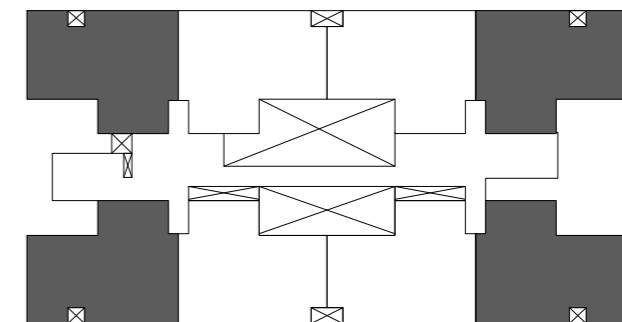
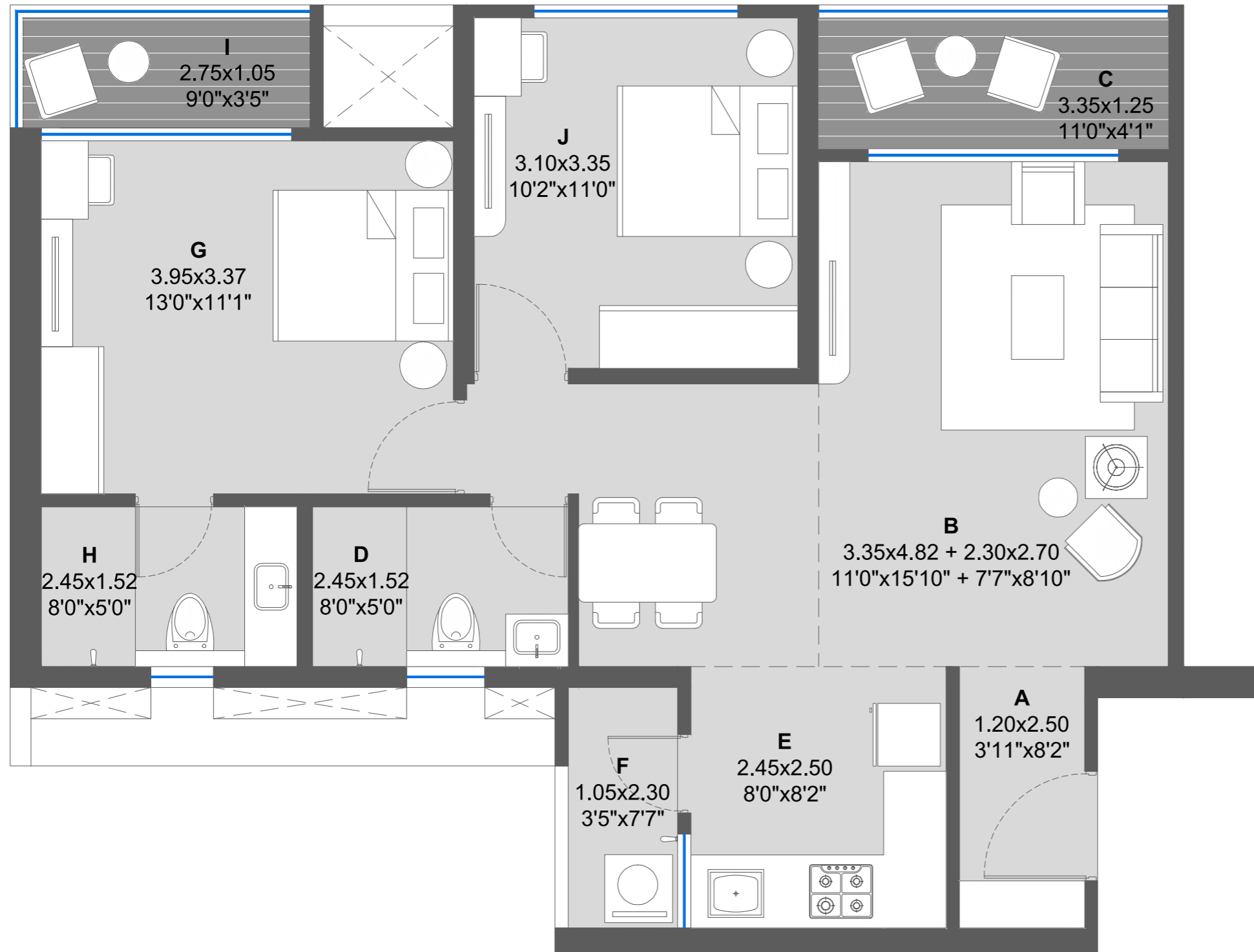

TYPICAL FLOOR - FLAT NO. 01/04/05/08

1. All Dimensions Are In Meter Unless Otherwise Specified
2. Dimensions & Areas Additionally Mentioned in Feet Inches & Square Feet Are Only For Customer's Understanding. Kindly Do Not Refer The Same For Any RERA Related Reference.



TOWER E

2 BHK MOMENT

Flat Carpet Area (Sq.m./Sq.ft): 68.57 / 738.09
 Balcony Area (Sq.m./Sq.ft): 9.49 / 102.15

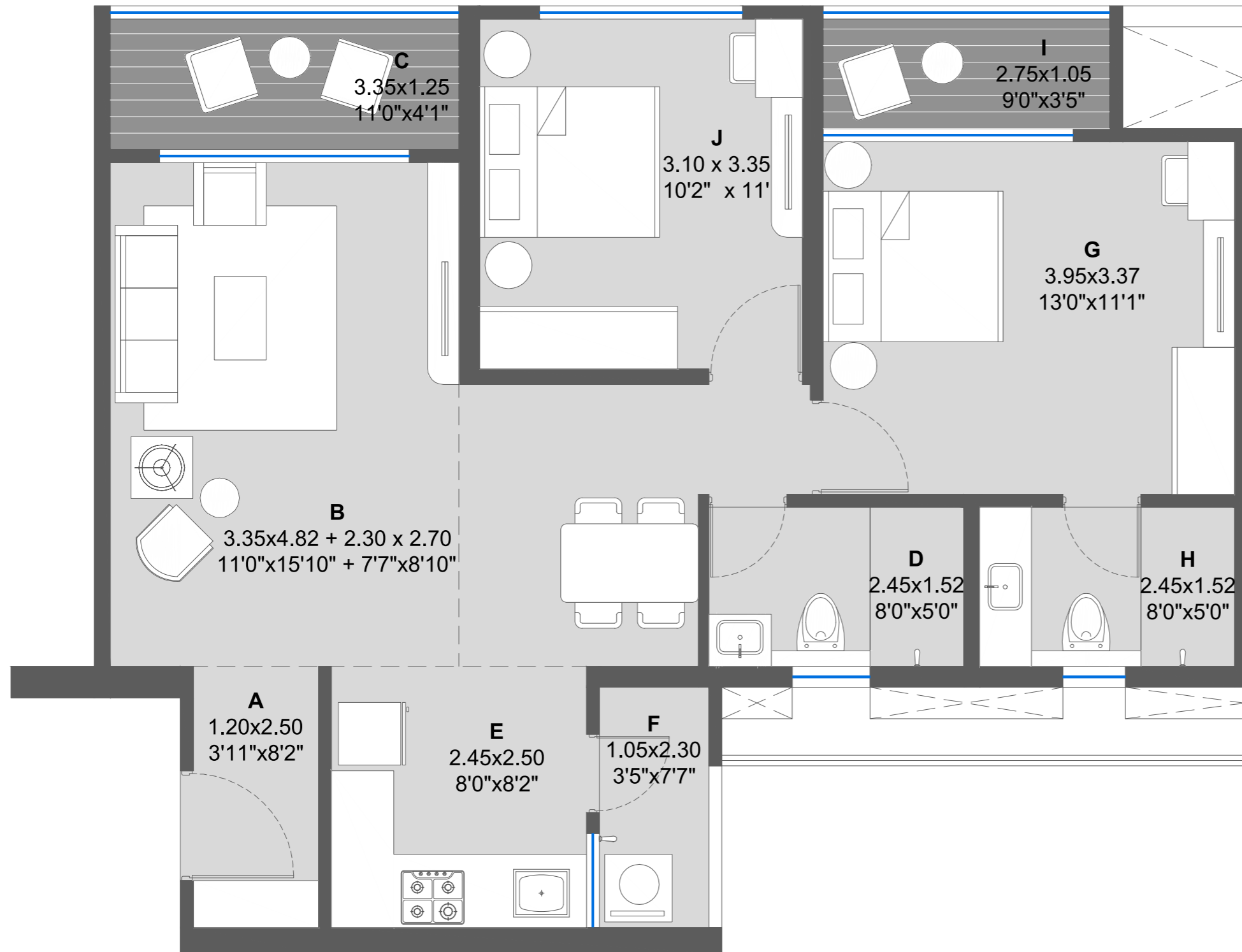

LIVING SPACE

- A. ENTRANCE LOBBY
- B. LIVING + DINING
- C. BALCONY
- D. TOILET

BEDROOMS

- G. MASTER BEDROOM
- H. TOILET
- I. BALCONY
- J. BEDROOM 01

KITCHEN SPACE

- E. KITCHEN
- F. BALCONY

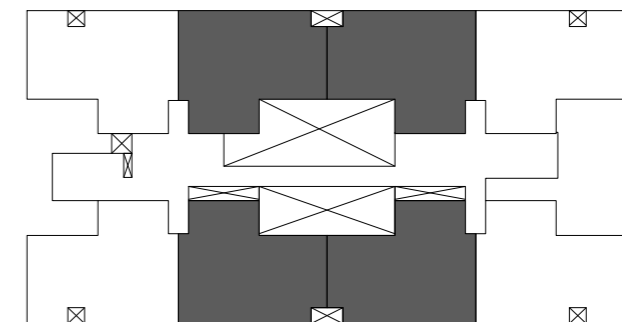

TYPICAL FLOOR - FLAT NO. 02/03/06/07

1. All Dimensions Are In Meter Unless Otherwise Specified
2. Dimensions & Areas Additionally Mentioned in Feet Inches & Square Feet Are Only For Customer's Understanding. Kindly Do Not Refer The Same For Any RERA Related Reference.

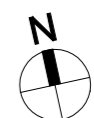

TOWER E

2.5 BHK (REFUGE) MEMORIA

Flat Carpet Area (Sq.m./Sq.ft): 87.29 / 939.59
 Balcony Area (Sq.m./Sq.ft): 12.38 / 133.26

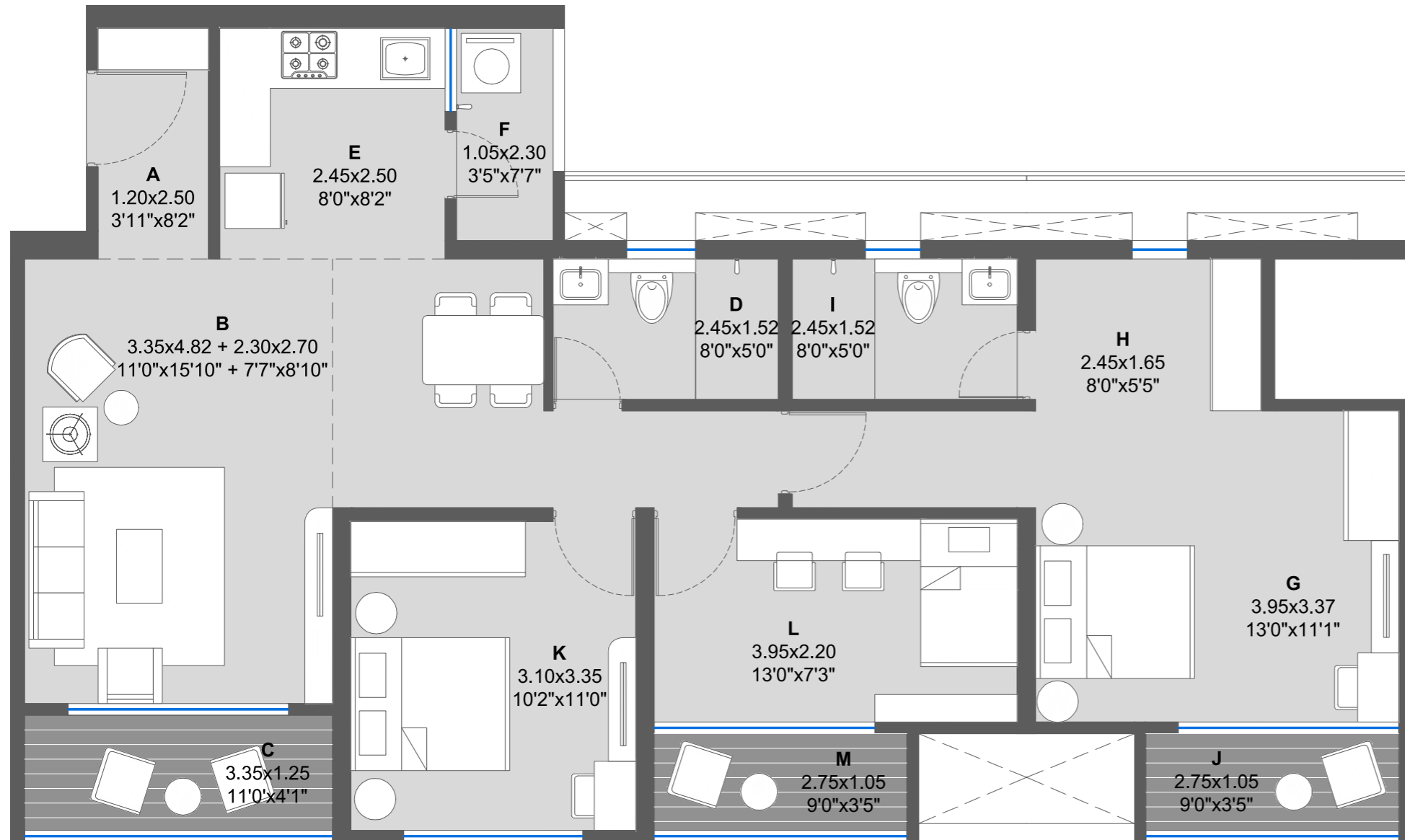

LIVING SPACE

- A. ENTRANCE LOBBY
- B. LIVING + DINING
- C. BALCONY
- D. TOILET

KITCHEN SPACE

- E. KITCHEN
- F. BALCONY

BEDROOMS

- G. MASTER BEDROOM
- H. WALK - IN WARDROBE
- I. TOILET
- J. BALCONY
- K. BEDROOM 01
- L. STUDY ROOM
- M. BALCONY

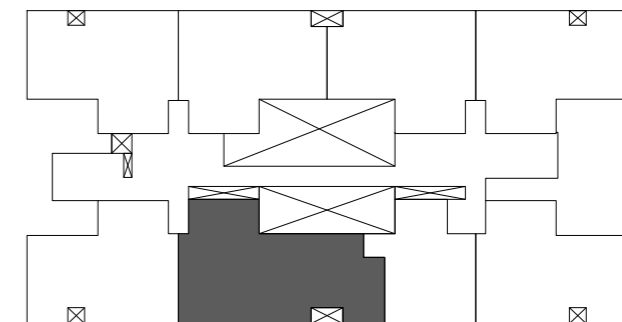

REFUGE FLOOR - FLAT NO. 803.

1. All Dimensions Are In Meter Unless Otherwise Specified
2. Dimensions & Areas Additionally Mentioned in Feet Inches & Square Feet Are Only For Customer's Understanding. Kindly Do Not Refer The Same For Any RERA Related Reference.

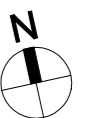



SPECIFICATION

LIVING ROOM

600X1200 Marble finish Vitrified flooring tiles

Gypsum-finished walls with semi acrylic paint

TV Point in Living room

UPVC frame with Tinted glass / heat reflective glass and mosquito net for windows.

Granite window sill

Designer main door (Engineered wood)

Provision of electrical points and sleeves for AC

Name plate will be provided

Only provision of electrical switch and socket for motorised curtains

KITCHEN

600X1200mm marble finish vitrified flooring tiles

300x600mm Designer Ceramic dado tile 2' above counter

Granite top kitchen platform with Sink (Carysil make satin finish)

Jaquar or equivalent CP fitting for kitchen

Provision for water purifier

Granite window sill

UPVC frame with Tinted glass / heat reflective glass and mosquito net for windows.

Sink (Carysil make satin finish) with granite platform (balcony adjacent to kitchen) for 2.5BHK units of A and B bldg. only

Provision of gas pipeline*

BEDROOMS

600X1200 marble finish vitrified flooring tiles

Granite window sill

Provision of electrical points and sleeves for AC

UPVC frame with tinted glass / heat reflective glass and mosquito net for windows.

ATTACHED TERRACE / BALCONY

SS + toughened glass safety railings for balcony

Ceramic wooden finish flooring tile in balcony

UPVC frame with tinted glass / heat reflective glass and mosquito net for balcony door.



*Services to be provided by 3rd party vendor



TOILETS

Engineered wood door shutter and WPC frame

Vitrified window sill

UPVC openable window with provision for exhaust fan

600x1200mm designer ceramic dado tiles up to lintel

600x600mm antiskid flooring

Counter top wash basin with vitrified platform

Jaquar or equivalent make CP fitting

Jaquar or equivalent make sanitary ware in all washrooms

Provision of electrical point for Geyser

ELECTRICAL

Legrand or equivalent brand modular switches in entire apartment

USB C & B port charging point in living room balcony

Provision of FITH (Fibre To The Home)*

HOME AUTOMATION FEATURES

Mobile application controllable touch switches & compatible voice assistance devices

For 2 BHK and 2.5 BHK automation(Light - on/off + Fan - on/off & speed control) in living, dining & master bedrooms

Digital lock for main door

Stand alone Video Door Phone in each unit

OTHERS

Elevators with generator back-up for each building

Texture paint for external wall

Gypsum-finished walls with semi acrylic paint

Earthquake Resistant structure confirming to IS code

Sensor based dimmable lights in covered parking areas only

Designated car wash area (1 car parking space with tap and drainage system to be provided)

*Services to be provided by 3rd party vendor



INTRODUCING 400+ ACRE INTEGRATED TOWNSHIP



A BIRD'S EYE VIEW

400+ ACRE INTEGRATED TOWNSHIP

This is not just an expansive green campus.
It is an urban lifestyle destination replete with
state-of-the-art facilities for education, healthcare,
daily necessities and leisure.
Situated in Pune's IT hub, it's a city itself with a
community that acts like a family



TOWNSHIP HIGHLIGHTS

GREENERY

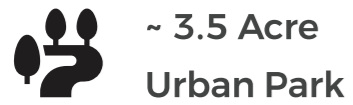

AMENITIES

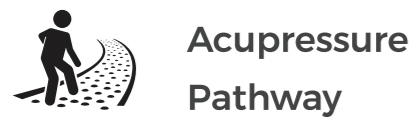

FACILITIES

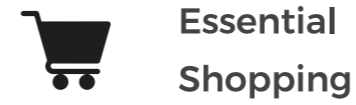
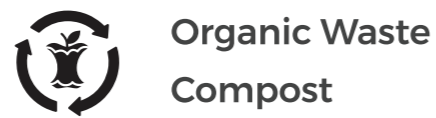
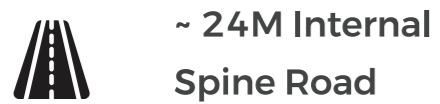

Actual Images

Certain facilities are subject to change*



Actual Image



Actual Image



Actual Image



Actual Image



Actual Image

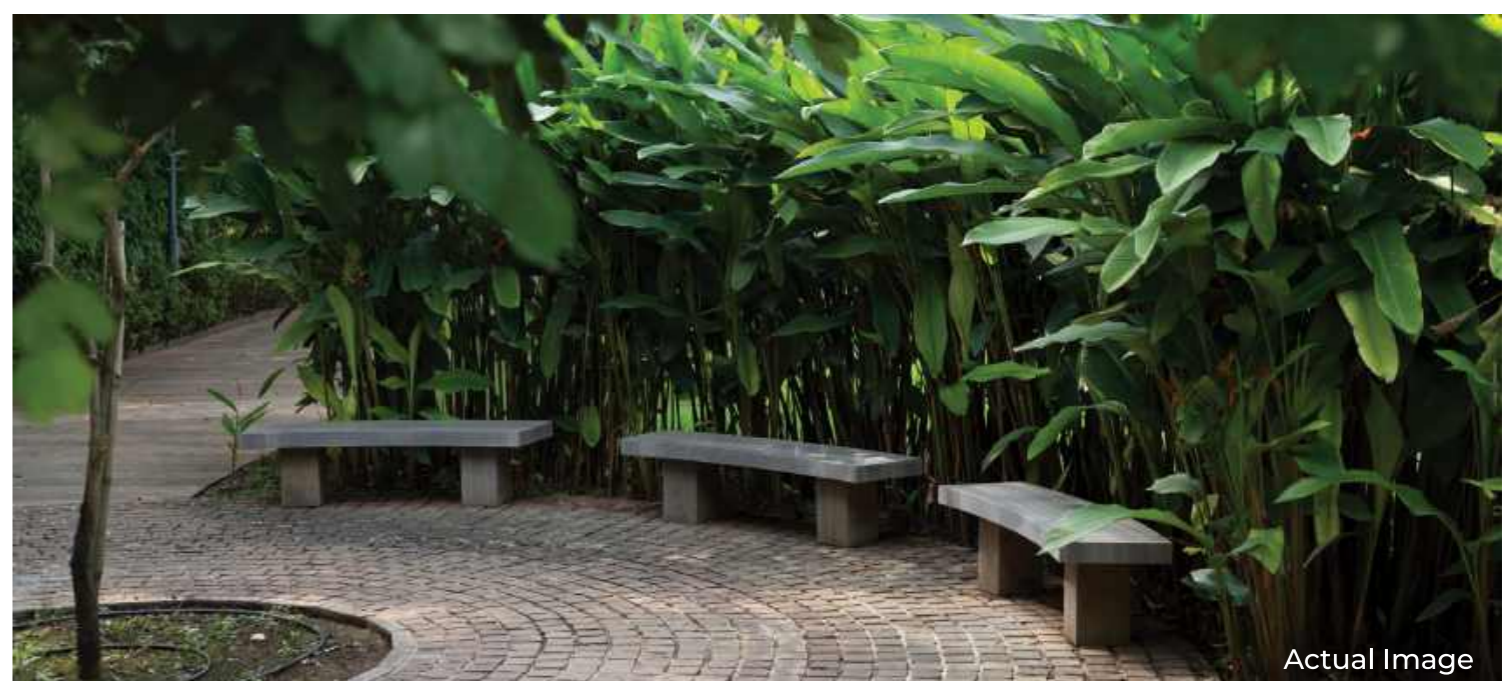

Actual Image

Location Highlights

SCHOOLS

- Crimson Anisha Global School
- Indira International School
- Akshara International School
- Vibgyor School
- Mahindra International School

SHOPPING MALL

- Phoenix Mall of the Millennium
- Elpro City Square Mall
- Grand High Street Mall
- Xion Mall Hinjawadi
- Vision One

ENTERTAINMENT

- PVR
- Carnival Cinemas
- INOX
- Butterfly Trampoline Park
- Dinosaur Garden

COLLEGES

- NICMAR
- Bharti Vidya Peeth
- DY Patil
- Indira Institute of Management
- JSPM
- Alard College
- IIMS

HOSPITAL

- Apollo Clinic
- Aditya Birla Hospital
- Surya Mother and Child Super Speciality Hospital
- Life Point Hospital
- Sahyadri Hospital













RETAIL & HIGH STREET

- D-Mart
- Smart Bazar
- Decathlon
- Balewadi High Street
- Croma

IT PARK

- TCS
- Wipro
- Infosys
- Embassy Tech Zone
- Quadron Business Park

LEGEND

-  Expressway
-  Main Roads
-  Main Roads Leading to Life Republic
-  Metro
-  Railway
-  Rivers
-  Bridge
-  Chowk
-  Railway Station
-  Junctions
-  Connecting Life Republic
-  Future Roads



Live in Harmony

30,000+ RESIDENTS

Another key highlight of owning a home within a township is having the help of a continuous support system. When the community is filled with friendly faces, it helps keep the heart happy. Similarly, having a known neighbourhood puts your mind at ease.

Thriving Community

Actual Images





MAHARERA NO.:

PM1261012502409

maharera.maharashtra.gov.in

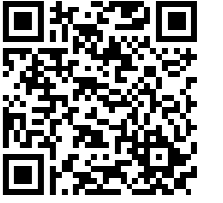

Life
REPUBLIC
By KOLTE-PATIL



Thriving Community

☎ 1800 266 2233 | www.liferepublic.in

Site office: Life Republic, Survey No. 74. Marunji, Hinjawadi-Marunji-Kasarsai Road, Taluka Mulshi, Pune - 411057

Disclaimer: All art renderings, illustrations, photographs and pictures contained in this brochure are an artist's impression only and the same should not be considered as the final view of the final project. Standard kitchen platform along with sink will be provided. Rest of the furniture and kitchen appliances are only for representation purpose. Unit areas shall be referred to as outlined in RERA application. Any discrepancies between the sanctioned dimensions and actual dimensions shall necessitate revisions as per RERA guidelines. Since the project is under evaluation, there is a possibility that there may be certain changes in the project as presented in this advertisement. Every interested purchaser should take note of this express representation. Kindly visit our website for the complete disclaimer.

For more information on future developments please refer to agreement for sale. *T&C Apply.